

ISOLATORS SERIES

ENCLOSED SWITCH
DISCONNECTORS





page 4

ISOLATORS-TP Series
Switch disconnectors
in thermoplastic
enclosure



page 22

ISOLATORS-INOX Series
Switch disconnectors
in stainless steel
enclosure



page 36

ISOLATORS-PH Series
DC switch disconnectors
in thermoplastic
enclosure



page 12

ISOLATORS-AL Series
Switch disconnectors
in aluminium enclosure



page 28

ISOLATORS-HR Series
High rating switch disconnectors in sheet
steel and thermoplastic enclosure





page 44 **Switch disconnectors with fuses**
Switch disconnectors in thermoplastic/aluminium/hinged sheet steel enclosure



page 58 **Change over switch disconnectors I/O/II**
Change over switch disconnectors in thermoplastic/aluminium/hinged sheet steel enclosure



page 40 **ISOLATORS-HD Series**
Switch disconnectors in heavy duty engineering plastic insulated enclosure



page 54 **ISOLATORS-FR Series**
Fire rated enclosed switch disconnectors



ISOLATORS-EX[GD] Series [2GD]
ISOLATORS-EX Series [2D]
For applications in hazardous environments
ATEX-IECEX-EAC Ex
REFER TO ATEX CATALOGUE

ISOLATORS-TP Series

Switch disconnectors

■ THERMOPLASTIC INSULATED ENCLOSURE - 16A-160A



The load-break switches and disconnectors in thermoplastic enclosures in the ISOLATORS-TP series are the basic solution for the majority of industrial and service applications.

Suitable for indoor or outdoor installation thanks to their high resistance to sun exposure, achieved by the use of UV stabilised materials, and their high IP66 and IP69 protection rating, which also allows installation in environments characterised by the use of high pressure and high temperature water cleaners

The exclusive and modern design means this range is also perfect for installations in the residential and service sector, where the large built-in handle not only guarantees an excellent grip, but also prevents any damage due to accidental contact, thus emphasising the already excellent impact resistance qualities (IK09), highly appreciated for applications in heavy-duty contexts.

Quick and easy to install thanks to the fixing holes located outside the base/cover connecting gasket, eliminating the need for additional drilling while also preventing the risk of compromising the IP rating due to imperfectly sealed holes.

The abundant space inside the enclosure, which facilitates operations, ensures more accurate wiring of terminals, even when maximum diameter conductors are used, while the reversibility of the base, with break-through cable inlets on one side and smooth walls with drilling point marks on the other, ensures rapid and flexible installation.

The load-break switches and disconnectors used guarantee line isolation in accordance with international standards and feature excellent characteristics for the interruption of typical inductive motor loads.

■ REFERENCE STANDARDS

EN 60947-3

Low voltage switchgear and controlgear.
Part 3: switches, disconnectors, switch-disconnectors and fuse-combination unit.

EN 60529

Degrees of protection provided by enclosure.

■ TECHNICAL CHARACTERISTICS

Polarity:	1P, 2P, 3P, 3P+N, 4P, 6P, 8P
Rated current:	16A*-20A-25A*-32A-40A-63A-80A-100A-125A-160A
Protection degree:	IP66/IP69 surface mounting version IP55 flush mounting version
Operating ambient temperature according to the reference standard:	-5°C +40°C
Min-Max. operating ambient temperature:	-25°C +60°C
Material:	Thermoplastic
IK degree:	IK09
Glow wire test:	650°C
Colour:	Grey RAL7035
Insulation class:	Class II (double insulation) □

2P and 3P+N configuration:

- switched neutral (early make late break).
- unswitched neutral (solid neutral terminal block ".SN" suffix).

Equipped with door locking.

Padlockable handle.

* Only for 6 and 8 poles.

■ BEHAVIOUR WITH CHEMICAL AND ATMOSPHERIC AGENTS

Saline solution	Acids		Bases		Solvents				Mineral oil	UV rays
	Concentrated	Diluted	Concentrated	Diluted	Hexane	Benzol	Acetone	Alcohol		
Resistant	Limited Resistance	Resistant	Resistant	Resistant	Not Resistant	Not Resistant	Not Resistant	Limited Resistance	Limited Resistance	Resistant

Resistance values to chemical agents have to be considered indicative.

For further information and specific substances, contact the technical service.

Dimensional drawings: www.scame.com

■ CABLE INLETS
Thermoplastic insulated enclosure 1P+SN, 2P, 3P, 3P+SN, 3P+N, 4P

Rated current (A)	Nr of poles	Enclosure dimensions (mm)	Cable entries		
20-32-40	1P+SN	82x120x69	Top	1xM20+1xM25	Knock-outs
			Bottom	1xM20+1xM25	Knock-outs
			Rear	2xM20	Knock-outs
20-32-40	1P+SN, 2P, 3P, 3P+SN, 3P+N, 4P	110x150x86	Top/Bottom	2xM25	Knock-outs/Blank side
			Rear	1xM25	Knock-outs/Blank side
63-80-100	1P+SN, 2P, 3P, 3P+SN, 3P+N, 4P	160x220x114	Top/Bottom (*)	2xM32	Knock-outs/Blank side
			Rear	2xM32	Knock-outs/Blank side
125	3P+SN, 3P+N, 4P	228x308x128	Top	-	Blank side (°)
			Bottom	-	Blank side (°)
			Rear	-	Blank side (°)
160	3P+SN, 3P+N, 4P	308x338x128	Top	-	Blank side (°)
			Bottom	-	Blank side (°)
			Rear	-	Blank side (°)

(*) Reversible base

(°) Perforated or threaded entries on request.

■ CABLE INLETS
Thermoplastic insulated enclosure 6P, 8P

Rated current (A)	Nr of poles	Enclosure dimensions (mm)	Cable entries		
16-25-32-40	6P, 8P	160x220x114	Top/Bottom	2xM32	Knock-outs/Blank side
			Rear	2xM32	Knock-outs/Blank side
63-80-100	6P, 8P	228x308x128	Top	-	Blank side (°)
			Bottom	-	Blank side (°)
			Rear	-	Blank side (°)
125-160	6P, 8P	308x338x128	Top	-	Blank side (°)
			Bottom	-	Blank side (°)
			Rear	-	Blank side (°)

(°) Perforated or threaded entries on request.

APPLICATION EXAMPLE

ISOLATORS-TP Series

Switch disconnectors

■ TECHNICAL CHARACTERISTICS 1P+SN

			20A	32A	40A	
Rated insulation voltage	Ui	VAC	250	250	250	
Rated impulse withstand voltage	Uimp	kV	4	4	4	
Thermal current	Ith/Ithe	A	20	32	40	
Rated operational current - Ie	AC22A Mixed resistive and inductive loads, including moderate overloads	250V	A	20	32	40
	AC23A Switching of motor loads or other highly inductive loads	250V	A	20	32	40
Rated short time withstand current	Icw (1s)	A	480	480	480	
Conditional short circuit current		kAeff	10	10	10	
Associate fuse size for conditional short circuit current - Type gG		A	20	32	40	
Flexible wire		mm ²	6	6	6	
Rigid wire		mm ²	6	6	6	

■ TECHNICAL CHARACTERISTICS 2P, 3P, 3P+SN, 3P+N, 4P

Switch size			Y1			Y2		Y4	Y5		
Rated current In			20A	32A	40A	63A	80A	100A	125A	160A	
Rated insulation voltage	Ui	VAC	690	690	690	690	690	800	800	800	
Rated impulse withstand voltage	Uimp	kV	4	4	4	8	8	8	8	8	
Thermal current	Ith/Ithe	A	20	32	40	63	80	100	125	160	
Rated operational current - Ie	AC21A Resistive loads, including moderate overloads	415V	A	20	32	40	63	80	100	125	160
		500V	A	20	32	32	63	80	100	125	160
		690V	A	20	32	32	63	80	100	125	160
	AC22A Mixed resistive and inductive loads, including moderate overloads	415V	A	20	32	40	63	80	100	125	160
		500V	A	20	32	32	63	80	100	125	160
		690V	A	20	32	32	63	80	100	125	160
	AC23A Switching of motor loads or other highly inductive loads (3 phase / 3 pole)	415V	A	20	32	35	63	67	100	125	160
		500V	A	20	25	25	40	67	-	125	125
		690V	A	20	25	25	30	38	-	100	100
	AC23A Rated operational power (°)	415V	Kw	9	15	18.5	33	37	46	55	69
	AC3 Squirrel-cage motor: starting, switching off motor during running (3 phase / 3 pole)	415V	A	18	25	28.5	40	55	-	-	-
		690V	A	12	18	20	25	32	-	-	-
	DC22A Mixed resistive and inductive loads, including moderate overloads	250V	A	25(*)	32(*)	32(*)	-	-	-	-	-
		600V	A	10(*)	10(*)	10(*)	-	-	-	-	-
Rated short time withstand current	Icw (1s)	A	400	400	400	1500	1500	1500	3000	3000	
Conditional short circuit current		kAeff	10	10	10	10	10	30	50	50	
Associate fuse size for conditional short circuit current - Type gG		A	20	32	40	63	80	100	125	125	
Flexible wire		mm ²	1.5-10	1.5-10	1.5-10	10-35	10-35	10-50	10-70	10-70	
Rigid wire		mm ²	1.5-16	1.5-16	1.5-16	10-35	10-35	10-50	10-70	10-70	

(*) Only 4P with 2+2 poles in series.

(°) This values are given for guidance and may vary according to the specifics provided by the motor manufacturer.

■ TECHNICAL CHARACTERISTICS 6P, 8P

Switch size			Y3				Y4			Y5		
Rated current I _n			16A	25A	32A	40A	63A	80A	100A	125A	160A	
Rated insulation voltage	U_i	VAC	800	800	800	800	800	800	800	800	800	
Rated impulse withstand voltage	U_{imp}	kV	8	8	8	8	8	8	8	8	8	
Thermal current	I_{th}/I_{the}	A	16	25	32	40	63	80	100	125	160	
Rated operational current – I _e	AC21A Resistive loads, including moderate overloads	415V	A	16	25	32	40	63	80	100	125	160
		500V	A	16	25	32	40	63	80	100	125	160
		690V	A	16	25	32	40	63	80	100	125	160
	AC22A Mixed resistive and inductive loads, including moderate overloads	415V	A	16	25	32	40	63	80	100	125	160
		500V	A	16	25	32	40	63	80	100	125	160
		690V	A	16	25	32	63	63	63	100	125	160
	AC23A Switching of motor loads or other highly inductive loads (3 phase / 3 pole)	415V	A	16	25	32	40	63	80	100	125	160
		500V	A	16	25	32	40	63	63	63	125	125
		690V	A	16	25	25	25	32	32	32	100	100
	AC23A Rated operational power (°)	415V	kW	7,5	11	15	18,5	35	37	46	55	69
Rated short time withstand current	I_{cs} (1s)	A	1100	1100	1100	1100	1500	1500	1500	3000	3000	
Conditional short circuit current		kA _{eff}	50	50	50	50	50	50	30	50	50	
Associate fuse size for conditional short circuit current - Type gG		A	16	25	32	40	63	80	100	125	125	
Flexible wire		mm ²	4-25	4-25	4-25	4-25	10-50	10-50	10-50	10-70	10-70	
Rigid wire		mm ²	4-25	4-25	4-25	4-25	10-50	10-50	10-50	10-70	10-70	

(°) This values are given for guidance and may vary according to the specifics provided by the motor manufacturer.

ISOLATORS-TP Series

Switch disconnectors - Thermoplastic enclosure

■ **SURFACE MOUNTING - IP66/IP69**
20A ÷ 40A - 1P+SN, 2P, 3P, 3P+SN, 3P+N, 4P, 6P, 8P

ISOLATORS-TP Series

		110x150x86 mm		110x150x86 mm		160x220x114 mm	
		EMERGENCY SWITCHING		GENERAL USE		EMERGENCY SWITCHING	
		GENERAL USE		EMERGENCY SWITCHING		GENERAL USE	
	Poles	Switch size					
16A	6P	Y3	1/5			590.EM1606	590.GE1606
	8P					590.EM1608	590.GE1608
20A	1P+SN	Y1	1/12	590.EM2022.SN	590.GE2022.SN	590.EM2012.SN	590.GE2012.SN
	2P					590.EM2012	590.GE2012
	3P					590.EM2013	590.GE2013
	3P+SN					590.EM2015.SN	590.GE2015.SN
	3P+N					590.EM2015	590.GE2015
	4P					590.EM2014	590.GE2014
25A	6P	Y3	1/5			590.EM2506	590.GE2506
	8P					590.EM2508	590.GE2508
32A	1P+SN	Y1	1/12	590.EM3222.SN	590.GE3222.SN	590.EM3212.SN	590.GE3212.SN
	2P					590.EM3212	590.GE3212
	3P					590.EM3213	590.GE3213
	3P+SN					590.EM3215.SN	590.GE3215.SN
	3P+N					590.EM3215	590.GE3215
	4P					590.EM3214	590.GE3214
	6P	Y3	1/5			590.EM3206	590.GE3206
	8P					590.EM3208	590.GE3208
40A	1P+SN	Y1	1/12	590.EM4022.SN	590.GE4022.SN	590.EM4012.SN	590.GE4012.SN
	2P					590.EM4012	590.GE4012
	3P					590.EM4013	590.GE4013
	3P+SN					590.EM4015.SN	590.GE4015.SN
	3P+N					590.EM4015	590.GE4015
	4P					590.EM4014	590.GE4014
	6P	Y3	1/5			590.EM4006	590.GE4006
	8P					590.EM4008	590.GE4008

Pack Quantity

- 3P+N with early make late break neutral pole.
- 8 poles with late break and early make neutral poles.
- Equipped with door locking.

- Switch disconnectors units suitable as spare parts available in the General catalogue. For 6 and 8 pole contact technical support.
- 1P+SN / 3P+SN: unswitched neutral (solid neutral terminal block)

■ SURFACE MOUNTING - IP66/IP69
63A ÷ 160A - 1P+SN, 2P, 3P, 3P+SN, 3P+N, 4P, 6P, 8P

ISOLATORS-TP Series

160x220x114 mm

228x308x128 mm (●)

308x338x128 mm (●)



Poles	Switch size	□	160x220x114 mm		228x308x128 mm (●)		308x338x128 mm (●)	
			EMERGENCY SWITCHING	GENERAL USE	EMERGENCY SWITCHING	GENERAL USE	EMERGENCY SWITCHING	GENERAL USE
63A	1P+SN	Y2	1/5	590.EM6302.SN	590.GE6302.SN			
	2P			590.EM6302	590.GE6302			
	3P			590.EM6303	590.GE6303			
	3P+SN			590.EM6305.SN	590.GE6305.SN			
	3P+N			590.EM6305	590.GE6305			
	4P			590.EM6304	590.GE6304			
	6P	Y4	1			590.EM6306	590.GE6306	
	8P					590.EM6308	590.GE6308	
80A	1P+SN	Y2	1/5	590.EM8002.SN	590.GE8002.SN			
	2P			590.EM8002	590.GE8002			
	3P			590.EM8003	590.GE8003			
	3P+SN			590.EM8005.SN	590.GE8005.SN			
	3P+N			590.EM8005	590.GE8005			
	4P			590.EM8004	590.GE8004			
	6P	Y4	1			590.EM8006	590.GE8006	
	8P					590.EM8008	590.GE8008	
100A	3P	Y4	1/5	590.EM10003	590.GE10003			
	3P+SN			590.EM10005.SN	590.GE10005.SN			
	3P+N			590.EM10005	590.GE10005			
	6P	1			590.EM10006	590.GE10006		
	8P				590.EM10008	590.GE10008		
125A	3P	Y5	1/5			590.EM12503	590.GE12503	
	3P+SN					590.EM12505.SN	590.GE12505.SN	
	3P+N			590.EM12505	590.GE12505			
	6P	1			590.EM12506	590.GE12506		
	8P				590.EM12508	590.GE12508		
160A	3P	Y5	1/5			590.EM16003	590.GE16003	
	3P+SN					590.EM16005.SN	590.GE16005.SN	
	3P+N			590.EM16005	590.GE16005			
	6P	1			590.EM16006	590.GE16006		
	8P				590.EM16008	590.GE16008		

□ Pack Quantity

- 3P+N with early make late break neutral pole.
- 8 poles with late break and early make neutral poles.
- Equipped with door locking.
- (●) Protection degree IP55.

- Switch disconnectors units suitable as spare parts available in the General catalogue.
- For 6 and 8 pole contact technical support.
- 1P+SN / 3P+SN: unswitched neutral (solid neutral terminal block).

Padlockable handle in one position (**OFF**).

Padlockable handle in two positions (**ON/OFF**).

ISOLATORS-TP Series

Switch disconnectors - Thermoplastic enclosure

■ SURFACE MOUNTING - IP66/IP69 - 16A ÷ 100A - 1P+SN, 2P, 3P, 3P+SN, 3P+N, 6P, 8P
PADLOCKABLE IN ON AND OFF POSITION WITH RED HANDLE

ISOLATORS-TP Series

110x150x86 mm

160x220x114 mm



	Poles	Switch size	☒	GENERAL USE	GENERAL USE
16A	6P	Y3	1/5		590.EL1606
	8P				590.EL1608
20A	1P+SN	Y1	1/5		590.EL2012.SN
	2P				590.EL2012
	3P				590.EL2013
	3P+SN				590.EL2015.SN
	3P+N				590.EL2015
25A	6P	Y3	1/5		590.EL2506
	8P				590.EL2508
32A	1P+SN	Y1	1/5		590.EL3212.SN
	2P				590.EL3212
	3P				590.EL3213
	3P+SN				590.EL3215.SN
	3P+N				590.EL3215
32A	6P	Y3	1/5		590.EL3206
	8P				590.EL3208
40A	1P+SN	Y1	1/5		590.EL4012.SN
	2P				590.EL4012
	3P				590.EL4013
	3P+SN				590.EL4015.SN
	3P+N				590.EL4015
40A	6P	Y3	1/5		590.EL4006
	8P				590.EL4008
63A	1P+SN	Y2	1/5		590.EL6302.SN
	2P				590.EL6302
	3P				590.EL6303
	3P+SN				590.EL6305.SN
	3P+N				590.EL6305
80A	1P+SN	Y2	1/5		590.EL8002.SN
	2P				590.EL8002
	3P				590.EL8003
	3P+SN				590.EL8005.SN
	3P+N				590.EL8005
100A	3P	Y4	1/5		590.EL10003
	3P+SN				590.EL10005.SN
	3P+N				590.EL10005

☒ Pack Quantity

- 3P+N with early make late break neutral pole.
- 8 poles with late break and early make neutral poles.
- Equipped with door locking

- Switch disconnectors units suitable as spare parts available in the General catalogue.
- For 6 and 8 pole contact technical support.
- 1P+SN / 3P+SN: unswitched neutral (solid neutral terminal block)

FLUSH MOUNTING - IP55
20A ÷ 40A - 2P, 3P, 3P+N, 4P

ISOLATORS-TP Series

136x125 mm



	Poles	Switch size	□		
				EMERGENCY SWITCHING	GENERAL USE
20A	2P	Y1	1/12	590.ER2002	590.GR2002
	3P			590.ER2003	590.GR2003
	3P+N			590.ER2005	590.GR2005
	4P			590.ER2004	590.GR2004
32A	2P	Y1	1/12	590.ER3202	590.GR3202
	3P			590.ER3203	590.GR3203
	3P+N			590.ER3205	590.GR3205
	4P			590.ER3204	590.GR3204
40A	2P	Y1	1/12	590.ER4002	590.GR4002
	3P			590.ER4003	590.GR4003
	3P+N			590.ER4005	590.GR4005
	4P			590.ER4004	590.GR4004

- To be completed with flush mounting boxes and frame

- 3P+N with early make late break neutral pole.
- 3P+SN: unswitched neutral (solid neutral terminal block)

FLUSH MOUNTING BOXES AND FRAME

ISOLATORS-TP Series

Description	IP degree	Dimensions (mm)	□	
Flush mounting box	-	160x148x72	1/6	572.0200
Flush mounting box for plasterboard walls	-	150x139x75	1/6	572.0205
Flame complete with gasket	IP55	174x163x19	1/6	572.0220
Coupling insert	-	-	1/6	572.0210
Box for Omnia 16/32A	IP67	136x125x70	1/6	572.0310

□ Pack Quantity

ISOLATORS-AL Series

Switch disconnectors

ALUMINIUM ENCLOSURE - 16A-160A



The ISOLATORS-AL range of load-break switches and disconnectors with enclosure in painted aluminium alloy, are particularly suited to applications requiring high-level resistance to chemical agents, humidity, dirt and dust, guaranteed by the IP66 protection rating and maximum mechanical resistance (IK10) preventing damage by accidental impact.

The fixing points for attachment to the external wall eliminate the need to make internal, often imperfectly sealed, thus preserving the protection rating, and the abundant wiring space in the area above the terminals also facilitates the bending of large diameter conductors.

The cable entry holes have already been inserted and threaded up to 100A for quick mounting and to ensure the protection rating of cable glands and fittings is perfectly maintained.

As with the entire ISOLATORS series, the load-break switches and disconnectors housed inside have a high short circuit breaking capacity, essential for the control of highly inductive and therefore critical loads, such as those generated by motors.

REFERENCE STANDARDS

EN 60947-3

Low voltage switchgear and controlgear.
Part 3: switches, disconnectors, switch-disconnectors and fuse-combination unit.

EN 60529

Degrees of protection provided by enclosure.

TECHNICAL CHARACTERISTICS

Polarity:	1P+SN, 2P, 3P, 3P+SN, 3P+N, 4P, 6P, 8P
Rated current:	16A*-20A-25A*-32A-40A-63A 80A-100A-125A-160A
Protection degree:	IP66
Operating ambient temperature according to the reference standard:	-5°C +40°C
Min-Max. operating ambient temperature:	-25°C +60°C
Material:	Die-cast aluminium
IK degree:	IK10
Colour:	Grey RAL7015

2P and 3P+N configuration:

- switched neutral (early make late break).
- unswitched neutral (solid neutral terminal block ".SN" suffix).

Equipped with door locking.

Padlockable handle.

* Only for 6 and 8 poles.

BEHAVIOUR WITH CHEMICAL AND ATMOSPHERIC AGENTS

Saline solution	Acids		Bases		Solvents				Mineral oil	UV rays
	Concentrated	Diluted	Concentrated	Diluted	Hexane	Benzol	Acetone	Alcohol		
Resistant	Limited Resistance	Resistant	Limited Resistance	Limited Resistance	Resistant	Limited Resistance	Limited Resistance	Resistant	Resistant	Resistant

Resistance values to chemical agents have to be considered indicative.

For further information and specific substances, contact the technical service.

Dimensional drawings: www.scame.com

■ CABLE INLETS

Aluminium enclosure 1P+SN, 2P, 3P, 3P+SN, 3P+N, 4P

Rated current (A)	Nr of poles	Enclosure dimensions (mm)	Cable entries		
20-32-40	1P+SN, 2P, 3P, 3P+SN, 3P+N, 4P	105x150x82	Top (*)	1xM20+1xM25	Threaded entries
			Bottom	1xM20+1xM25	Threaded entries
			Rear	-	Blank side (°)
63-80-100	1P+SN, 2P, 3P, 3P+SN, 3P+N, 4P	150x210x107	Top (*)	2xM32	Threaded entries
			Bottom	2xM32	Threaded entries
			Rear	-	Blank side (°)
125	3P, 3P+SN, 3P+N	264x315x122	Top	-	Blank side (°)
			Bottom	-	Blank side (°)
			Rear	-	Blank side (°)
160	3P, 3P+SN, 3P+N	315x410x153	Top	-	Blank side (°)
			Bottom	-	Blank side (°)
			Rear	-	Blank side (°)

(°) Perforated or threaded entries on request.

(*) "A" version blank side bottom cable entries only.

■ CABLE INLETS

Aluminium enclosure 6P, 8P

Rated current (A)	Nr of poles	Enclosure dimensions (mm)	Cable entries		
16-25-32-40	6P, 8P	150x210x107	Top (*)	-	Blank side (°)
			Bottom	-	Blank side (°)
			Rear	-	Blank side (°)
63-80-100	6P, 8P	264x315x122	Top	-	Blank side (°)
			Bottom	-	Blank side (°)
			Rear	-	Blank side (°)
125-160	6P, 8P	315x410x153	Top	-	Blank side (°)
			Bottom	-	Blank side (°)
			Rear	-	Blank side (°)

(°) Perforated or threaded entries on request.

(*) "A" version blank side bottom cable entries only.

CABLE ENTRY OPTIONS

Maximum cable entry flexibility with Top and Bottom double open threaded holes available with standard version from 20 up to 100A.

Special version with blank side on top and double open threaded holes cable entries on bottom to prevent loss of IP degree due to wrong installation or accidental alteration of the caps provided.

For bottom cable entry, add ".A" suffix at the end of catalogue number.



ISOLATORS-AL Series

Switch disconnectors

■ TECHNICAL CHARACTERISTICS 1P+SN

			20A	32A	40A	
Rated insulation voltage	Ui	VAC	250	250	250	
Rated impulse withstand voltage	Uimp	kV	4	4	4	
Thermal current	Ith/Ithe	A	20	32	40	
Rated operational current - Ie	AC22A Mixed resistive and inductive loads, including moderate overloads	250V	A	20	32	40
	AC23A Switching of motor loads or other highly inductive loads	250V	A	20	32	40
Rated short time withstand current	Icw (1s)	A	480	480	480	
Conditional short circuit current		kAeff	10	10	10	
Associate fuse size for conditional short circuit current - Type gG		A	20	32	40	
Flexible wire		mm ²	6	6	6	
Rigid wire		mm ²	6	6	6	

■ TECHNICAL CHARACTERISTICS 2P, 3P, 3P+SN, 3P+N, 4P

Switch size			Y1			Y2		Y4	Y5		
Rated current In			20A	32A	40A	63A	80A	100A	125A	160A	
Rated insulation voltage	Ui	VAC	690	690	690	690	690	800	800	800	
Rated impulse withstand voltage	Uimp	kV	4	4	4	8	8	8	8	8	
Thermal current	Ith/Ithe	A	20	32	40	63	80	100	125	160	
Rated operational current - Ie	AC21A Resistive loads, including moderate overloads	415V	A	20	32	40	63	80	100	125	160
		500V	A	20	32	32	63	80	100	125	160
		690V	A	20	32	32	63	80	100	125	160
	AC22A Mixed resistive and inductive loads, including moderate overloads	415V	A	20	32	40	63	80	100	125	160
		500V	A	20	32	32	63	80	100	125	160
		690V	A	20	32	32	63	80	100	125	160
	AC23A Switching of motor loads or other highly inductive loads (3 phase / 3 pole)	415V	A	20	32	35	63	67	100	125	160
		500V	A	20	25	25	40	67	-	125	125
		690V	A	20	25	25	30	38	-	100	100
	AC23A Rated operational power (°)	415V	Kw	9	15	18.5	33	37	46	55	69
	AC3 Squirrel-cage motor: starting, switching off motor during running (3 phase / 3 pole)	415V	A	18	25	28.5	40	55	-	-	-
		690V	A	12	18	20	25	32	-	-	-
	DC22A Mixed resistive and inductive loads, including moderate overloads	250V	A	25(*)	32(*)	32(*)	-	-	-	-	-
		600V	A	10(*)	10(*)	10(*)	-	-	-	-	-
Rated short time withstand current	Icw (1s)	A	400	400	400	1500	1500	1500	3000	3000	
Conditional short circuit current		kAeff	10	10	10	10	10	30	50	50	
Associate fuse size for conditional short circuit current - Type gG		A	20	32	40	63	80	100	125	125	
Flexible wire		mm ²	1.5-10	1.5-10	1.5-10	10-35	10-35	10-50	10-70	10-70	
Rigid wire		mm ²	1.5-16	1.5-16	1.5-16	10-35	10-35	10-50	10-70	10-70	

(*) Only 4P with 2+2 poles in series.

(°) This values are given for guidance and may vary according to the specifics provided by the motor manufacturer.

■ TECHNICAL CHARACTERISTICS 6P, 8P

Switch size			Y3				Y4			Y5		
Rated current In			16A	25A	32A	40A	63A	80A	100A	125A	160A	
Rated insulation voltage	Ui	VAC	800	800	800	800	800	800	800	800	800	
Rated impulse withstand voltage	Uimp	kV	8	8	8	8	8	8	8	8	8	
Thermal current	Ith/Ithe	A	16	25	32	40	63	80	100	125	160	
Rated operational current – Ie	AC21A Resistive loads, including moderate overloads	415V	A	16	25	32	40	63	80	100	125	160
		500V	A	16	25	32	40	63	80	100	125	160
		690V	A	16	25	32	40	63	80	100	125	160
	AC22A Mixed resistive and inductive loads, including moderate overloads	415V	A	16	25	32	40	63	80	100	125	160
		500V	A	16	25	32	40	63	80	100	125	160
		690V	A	16	25	32	40	63	80	100	125	160
	AC23A Switching of motor loads or other highly inductive loads (3 phase / 3 pole)	415V	A	16	25	32	40	63	80	100	125	160
		500V	A	16	25	32	40	63	63	63	125	125
		690V	A	16	25	25	25	32	32	32	100	100
	AC23A Rated operational power (°)	415V	kW	7,5	11	15	18,5	35	37	46	55	69
	Rated short time withstand current	Icw (1s)	A	1100	1100	1100	1100	1500	1500	1500	3000	3000
	Conditional short circuit current		kAeff	50	50	50	50	50	50	30	50	50
Associate fuse size for conditional short circuit current - Type gG		A	16	25	32	40	63	80	100	125	125	
Flexible wire		mm²	4-25	4-25	4-25	4-25	10-50	10-50	10-50	10-70	10-70	
Rigid wire		mm²	4-25	4-25	4-25	4-25	10-50	10-50	10-50	10-70	10-70	

(°) This values are given for guidance and may vary according to the specifics provided by the motor manufacturer.

■ TECHNICAL CHARACTERISTICS 1P+SN, 2P, 3P, 3P+SN, 3P+N, HIGH WIRING CAPACITY

Switch size			K1		K2	
Rated current In			100A	125A	160A	
Rated insulation voltage	Ui	(V)	1000	1000	1000	
Rated impulse withstand voltage	Uimp	(kV)	8	8	12	
Thermal current	Ith/Ithe	(A)	100	125	160	
Rated operational current – Ie	AC21A/B Resistive loads, including moderate overloads	415V	(A)	100	125	160
		500V	(A)	100	125	160
		690V	(A)	100	125	160
	AC22A/B Mixed resistive and inductive loads, including moderate overloads	415V	(A)	100	125	160
		500V	(A)	100	125	160
		690V	(A)	100	125	160
	AC23A/B Switching of motor loads or other highly inductive loads (3 phase / 3 pole)	415V	(A)	100	125	160
		500V	(A)	80	100	125
		690V	(A)	63	80	100
	AC23A Rated operational power (°)	415V	kW	52	65	85
	Rated making capacity	415V	(A)	1000	1250	1600
		AC23				
Rated breaking capacity	415V	(A)	800	1000	1280	
	AC23					
Short circuit withstand current 1sec		(kA)	5	5	8	
Short circuit withstand current 0.25 sec		(kA)	10	10	16	
Short circuit making capacity	415V	(kA)	7,5	7,5	13.5	
Rated fuse short-circuit current	Back up fuse	(A)	100	125	160	
	R.M.S value	(kA)	50	50	50	
	Peak value	(kA)	12	15	16	
Cable section		mm²	35	50	120	
Bars dimension		mm	14x3	16x3	20x5	

Full current neutral pole available on request.









(°) This values are given for guidance and may vary according to the specifics provided by the motor manufacturer.

ISOLATORS-AL Series

Switch disconnectors - Aluminium enclosure

■ SURFACE MOUNTING - IP66
16A ÷ 40A - 1P+SN, 2P, 3P, 3P+SN, 3P+N, 4P, 6P, 8P

ISOLATORS-AL Series

				105x150x82 mm (*)		150x210x107 mm (*)	
							
				EMERGENCY SWITCHING	GENERAL USE	EMERGENCY SWITCHING	GENERAL USE
							
Poles	Switch size						
16A	6P	Y3	1/5			590.HEM1606	590.HGE1606
	8P					590.HEM1608	590.HGE1608
	1P+SN			590.HEM2002.SN	590.HGE2002.SN		
	2P			590.HEM2002	590.HGE2002		
	3P			590.HEM2003	590.HGE2003		
	3P+SN			590.HEM2005.SN	590.HGE2005.SN		
	3P+N			590.HEM2005	590.HGE2005		
4P			590.HEM2004	590.HGE2004			
25A	6P	Y3	1/5			590.HEM2506	590.HGE2506
	8P					590.HEM2508	590.HGE2508
	1P+SN			590.HEM3202.SN	590.HGE3202.SN		
	2P			590.HEM3202	590.HGE3202		
	3P			590.HEM3203	590.HGE3203		
	3P+SN			590.HEM3205.SN	590.HGE3205.SN		
	3P+N			590.HEM3205	590.HGE3205		
	4P			590.HEM3204	590.HGE3204		
	6P	Y3	1/5			590.HEM3206	590.HGE3206
	8P					590.HEM3208	590.HGE3208
	1P+SN			590.HEM4002.SN	590.HGE4002.SN		
	2P			590.HEM4002	590.HGE4002		
	3P			590.HEM4003	590.HGE4003		
	3P+SN			590.HEM4005.SN	590.HGE4005.SN		
3P+N			590.HEM4005	590.HGE4005			
4P			590.HEM4004	590.HGE4004			
6P	Y3	1/5			590.HEM4006	590.HGE4006	
8P					590.HEM4008	590.HGE4008	

 Pack Quantity

- 3P+N with early make late break neutral pole.
- 8 poles with late break and early make neutral poles.
- Equipped with door locking.

- Switch disconnectors units suitable as spare parts available in the General catalogue. For 6 and 8 pole contact technical support.
- (*) Add ".A" suffix at the end of the catalogue number for bottom cable entries only.
- 1P+SN / 3P+SN: unswitched neutral (solid neutral terminal block)

SURFACE MOUNTING - IP66
63A ÷ 100A - 1P+SN, 2P, 3P, 3P+SN, 3P+N, 4P, 6P, 8P

ISOLATORS-AL Series

				150x210x107 mm (*)	264x315x122 mm (●)	
				EMERGENCY SWITCHING	GENERAL USE	
				EMERGENCY SWITCHING	GENERAL USE	
63A	1P+SN	Y2	1/5	590.HEM6302.SN	590.HGE6302.SN	
	2P			590.HEM6302	590.HGE6302	
	3P			590.HEM6303	590.HGE6303	
	3P+SN			590.HEM6305.SN	590.HGE6305.SN	
	3P+N			590.HEM6305	590.HGE6305	
	4P			590.HEM6304	590.HGE6304	
	6P	Y4	1		590.HEM6306	590.HGE6306
	8P				590.HEM6308	590.HGE6308
80A	1P+SN	Y2	1/5	590.HEM8002.SN	590.HGE8002.SN	
	2P			590.HEM8002	590.HGE8002	
	3P			590.HEM8003	590.HGE8003	
	3P+SN			590.HEM8005.SN	590.HGE8005.SN	
	3P+N			590.HEM8005	590.HGE8005	
	4P			590.HEM8004	590.HGE8004	
	6P	Y4	1		590.HEM8006	590.HGE8006
	8P				590.HEM8008	590.HGE8008
100A	3P	Y4	1/5	590.HEM10003	590.HGE10003	
	3P+SN			590.HEM10005.SN	590.HGE10005.SN	
	3P+N			590.HEM10005	590.HGE10005	
	6P	1		590.HEM10006	590.HGE10006	
	8P			590.HEM10008	590.HGE10008	

□ Pack Quantity

- 3P+N with early make late break neutral pole.
- 8 poles with late break and early make neutral poles.
- Equipped with door locking.
- (●) Protection degree IP65

- Switch disconnectors units suitable as spare parts available in the General catalogue. For 6 and 8 pole contact technical support.
- (*) Add ".A" suffix at the end of the catalogue number for bottom cable entries only.
- 1P+SN / 3P+SN: unswitched neutral (solid neutral terminal block)

	Padlockable handle in one position (OFF).
	Padlockable handle in two positions (ON/OFF).

ISOLATORS-AL Series

Switch disconnectors - Aluminium enclosure

■ SURFACE MOUNTING - IP65
125A ÷ 160A - 3P, 3P+SN, 3P+N, 6P, 8P

ISOLATORS-AL Series

264x315x122 mm

315x410x153 mm



	Poles	Switch size	☐	264x315x122 mm		315x410x153 mm	
				EMERGENCY SWITCHING	GENERAL USE	EMERGENCY SWITCHING	GENERAL USE
125A	3P	Y5	1	590.HEM12503	590.HGE12503		
	3P+SN			590.HEM12505.SN	590.HGE12505.SN		
	3P+N			590.HEM12505	590.HGE12505		
	6P					590.HEM12506	590.HGE12506
	8P					590.HEM12508	590.HGE12508
160A	3	Y5	1			590.HEM16003	590.HGE16003
	3P+SN					590.HEM16005.SN	590.HGE16005.SN
	3P+N					590.HEM16005	590.HGE16005
	6					590.HEM16006	590.HGE16006
	8					590.HEM16008	590.HGE16008









☐ Pack Quantity

- 3P+N with early make late break neutral pole.
- 8 poles with late break and early make neutral poles.
- Equipped with door locking.

- Switch disconnectors units suitable as spare parts available in the General catalogue. For 6 and 8 pole contact technical support.
- 3P+SN: unswitched neutral (solid neutral terminal block)



■ SURFACE MOUNTING - IP66 - 20A ÷ 100A - 1P+SN, 2P, 3P, 3P+SN, 3P+N, 6P, 8P
 PADLOCKABLE IN ON AND OFF POSITION WITH RED HANDLE

ISOLATORS-AL Series

				105x150x82 mm (*)	150x210x107 mm (*)
					
					
				GENERAL USE  	GENERAL USE  
	Poles	Switch size			
16A	6P	Y3	1/5		590.HEL1606
	8P			590.HEL1608	
20A	1P+SN	Y1	1/5		590.HEL2002.SN
	2P			590.HEL2002	
	3P			590.HEL2003	
	3P+SN			590.HEL2005.SN	
	3P+N			590.HEL2005	
25A	6P	Y3	1/5		590.HEL2506
	8P			590.HEL2508	
32A	1P+SN	Y1	1/5		590.HEL3202.SN
	2P			590.HEL3202	
	3P			590.HEL3203	
	3P+SN			590.HEL3205.SN	
	3P+N			590.HEL3205	
	6P	Y3	1/5		590.HEL3206
	8P			590.HEL3208	
40A	1P+SN	Y1	1/5		590.HEL4002.SN
	2P			590.HEL4002	
	3P			590.HEL4003	
	3P+SN			590.HEL4005.SN	
	3P+N			590.HEL4005	
	6P	Y3	1/5		590.HEL4006
	8P			590.HEL4008	
63A	1P+SN	Y3	1/5		590.HEL6302.SN
	2P			590.HEL6302	
	3P			590.HEL6303	
	3P+SN			590.HEL6305.SN	
	3P+N			590.HEL6305	
80A	1P+SN	Y3	1/5		590.HEL8002.SN
	2P			590.HEL8002	
	3P			590.HEL8003	
	3P+SN			590.HEL8005.SN	
	3P+N			590.HEL8005	
100A	3P	Y3	1/5		590.HEL10003
	3P+SN			590.HEL10005.SN	
	3P+N			590.HEL10005	

-  Pack Quantity
- 3P+N with early make late break neutral pole.
 - 8 poles with late break and early make neutral poles.
 - Equipped with door locking.
 - Switch disconnectors units suitable as spare parts available in the

- General catalogue.
 For 6 and 8 pole contact technical support.
- (*) Add ".A" suffix at the end of the catalogue number for bottom cable entries only.
 - 1P+SN / 3P+SN: unswitched neutral (solid neutral terminal block)

	Padlockable handle in one position (OFF).
	Padlockable handle in two positions (ON/OFF).

ISOLATORS-AL Series

Switch disconnectors - Aluminium enclosure

■ SURFACE MOUNTING - IP65
16A ÷ 100A - 1P+SN, 2P, 3P, 3P+SN, 3P+N, 6P, 8P - HIGH WIRING CAPACITY

ISOLATORS-AL Series

264x315x122 mm



	Poles	Switch size	□	EMERGENCY SWITCHING		GENERAL USE	
				■	■	■	■
16A	6P	Y3	1	590.HEM1606.W		590.HGE1606.W	
	8P			590.HEM1608.W		590.HGE1608.W	
20A	1P+SN	Y1	1	590.HEM2002.W.SN		590.HGE2002.W.SN	
	2P			590.HEM2002.W		590.HGE2002.W	
	3P			590.HEM2003.W		590.HGE2003.W	
	3P+SN			590.HEM2005.W.SN		590.HGE2005.W.SN	
	3P+N			590.HEM2005.W		590.HGE2005.W	
25A	6P	Y3	1	590.HEM2506.W		590.HGE2506.W	
	8P			590.HEM2508.W		590.HGE2508.W	
32A	1P+SN	Y1	1	590.HEM3202.W.SN		590.HGE3202.W.SN	
	2P			590.HEM3202.W		590.HGE3202.W	
	3P			590.HEM3203.W		590.HGE3203.W	
	3P+SN			590.HEM3205.W.SN		590.HGE3205.W.SN	
	3P+N			590.HEM3205.W		590.HGE3205.W	
	6P			590.HEM3206.W		590.HGE3206.W	
	8P			590.HEM3208.W		590.HGE3208.W	
	1P+SN			590.HEM4002.W.SN		590.HGE4002.W.SN	
40A	2P	590.HEM4002.W		590.HGE4002.W			
	3P	590.HEM4003.W		590.HGE4003.W			
	3P+SN	590.HEM4005.W.SN		590.HGE4005.W.SN			
	3P+N	590.HEM4005.W		590.HGE4005.W			
	6P	590.HEM4006.W		590.HGE4006.W			
	8P	590.HEM4008.W		590.HGE4008.W			

□ Pack Quantity

- 3P+N with early make late break neutral pole.
- Equipped with door locking.

- Switch disconnectors units suitable as spare parts available in the General catalogue.
- 1P+SN / 3P+SN: unswitched neutral (solid neutral terminal block).

SURFACE MOUNTING - IP65
63A ÷ 160A - 1P+SN, 2P, 3P, 3P+SN, 3P+N, 6P, 8P - HIGH WIRING CAPACITY

ISOLATORS-AL Series

264x315x122 mm

315x410x153 mm



Poles	Switch size	P	264x315x122 mm		315x410x153 mm		
			EMERGENCY SWITCHING	GENERAL USE	EMERGENCY SWITCHING	GENERAL USE	
63A	1P+SN	Y2	1			590.HEM6302.W.SN	590.HGE6302.W.SN
	2P					590.HEM6302.W	590.HGE6302.W
	3P					590.HEM6303.W	590.HGE6303.W
	3P+SN	Y4	1			590.HEM6305.W.SN	590.HGE6305.W.SN
	3P+N					590.HEM6305.W	590.HGE6305.W
	6P					590.HEM6306.W	590.HGE6306.W
	8P					590.HEM6308.W	590.HGE6308.W
80A	1P+SN	Y4	1			590.HEM8002.W.SN	590.HGE8002.W.SN
	2P					590.HEM8002.W	590.HGE8002.W
	3P					590.HEM8003.W	590.HGE8003.W
	3P+SN	Y4	1			590.HEM8005.W.SN	590.HGE8005.W.SN
	3P+N					590.HEM8005.W	590.HGE8005.W
	6P					590.HEM8006.W	590.HGE8006.W
	8P					590.HEM8008.W	590.HGE8008.W
100A	3P	Y4	1	590.HEM10003.W	590.HGE10003.W		
	3P+SN			590.HEM10005.W.SN	590.HGE10005.W.SN		
	3P+N			590.HEM10005.W	590.HGE10005.W		
	6P					590.HEM10006.W	590.HGE10006.W
	8P					590.HEM10008.W	590.HGE10008.W
125A	3P	Y5	1			590.HEM12503.W	590.HGE12503.W
	3P+SN					590.HEM12505.W.SN	590.HGE12505.W.SN
	3P+N					590.HEM12505.W	590.HGE12505.W
160A	3P	Y5	1			590.HEM16003.W	590.HGE16003.W
	3P+SN					590.HEM16005.W.SN	590.HGE16005.W.SN
	3P+N					590.HEM16005.W	590.HGE16005.W

P Pack Quantity

- 3P+N with early make late break neutral pole.
- Equipped with door locking.

- Switch disconnectors units suitable as spare parts available in the General catalogue.
- 1P+SN / 3P+SN: unswitched neutral (solid neutral terminal block).

	Padlockable handle in one position (OFF).
	Padlockable handle in two positions (ON/OFF).

ISOLATORS-INOX Series

Switch disconnectors

■ STAINLESS STEEL ENCLOSURE - 16A-160A



ISOLATORS with stainless steel enclosure are the ideal solution for the food and pharmaceutical sector, which require high resistance against corrosion and particularly aggressive detergents used to guarantee a high level of hygiene.

The material used for the enclosure also satisfies the requirements for installation in more heavy duty industrial environments, in ports or docks with a high salt content or in pools with high levels of chlorine

These versions share all the excellent electrical characteristics of the load-break switches and disconnectors in the rest of the ISOLATORS range.

■ REFERENCE STANDARDS

EN 60947-3

Low voltage switchgear and controlgear.
Part 3: switches, disconnectors, switch-disconnectors and fuse-combination unit.

EN 60529

Degrees of protection provided by enclosure.

■ TECHNICAL CHARACTERISTICS

Polarity:	1P+SN, 2P, 3P, 3P+SN, 3P+N, 6P, 8P
Rated current:	16A*-20A-25A*-32A-40A-63A 80A-100A-125A-160A
Protection degree:	IP65
Operating ambient temperature according to the reference standard:	-5°C +40°C
Min-Max. operating ambient temperature:	-25°C +60°C
IK degree:	IK10
Material:	Stainless steel 304L (316L stainless steel on request)

2P and 3P+N configuration:

- switched neutral (early make late break).
- unswitched neutral (solid neutral terminal block ".SN" suffix).

Equipped with door locking.

Padlockable handle.

* Only for 6 poles.

■ BEHAVIOUR WITH CHEMICAL AND ATMOSPHERIC AGENTS

Saline solution	Acids		Bases		Solvents				Mineral oil	UV rays
	Concentrated	Diluted	Concentrated	Diluted	Hexane	Benzol	Acetone	Alcohol		
Resistant	Limited Resistance	Resistant	Resistant	Resistant	Resistant	Resistant	Resistant	Resistant	Resistant	Resistant

Resistance values to chemical agents have to be considered indicative.

For further information and specific substances, contact the technical service.

Dimensional drawings: www.scame.com

■ CABLE INLETS
Stainless steel enclosure 1P+SN, 2P, 3P, 3P+SN, 3P+N

Rated current (A)	Nr of poles	Enclosure dimensions (mm)	Cable entries		
			Top	Bottom	Rear
20-32-40	1P+SN, 2P, 3P, 3P+SN, 3P+N	100x160x90	Top	-	Blank side
			Bottom	-	Blank side
			Rear	-	Blank side
63-80-100	3P, 3P+SN, 3P+N	150x220x120	Top	-	Blank side
			Bottom	-	Blank side
			Rear	-	Blank side
125-160	3P, 3P+SN, 3P+N	300x400x150	Top	-	Blank side
			Bottom	-	Blank side
			Rear	-	Blank side

Perforated or threaded entries on request.

■ CABLE INLETS
Stainless steel enclosure 6P, 8P

Rated current (A)	Nr of poles	Enclosure dimensions (mm)	Cable entries		
			Top	Bottom	Rear
16-25-32-40-63-80-100	6P, 8P	250x280x120	Top	-	Blank side
			Bottom	-	Blank side
			Rear	-	Blank side
125-160	6P, 8P	300x400x150	Top	-	Blank side
			Bottom	-	Blank side
			Rear	-	Blank side

Perforated or threaded entries on request.

APPLICATION EXAMPLE

ISOLATORS-INOX Series

Switch disconnectors

■ TECHNICAL CHARACTERISTICS 1P+SN

			20A	32A	40A	
Rated insulation voltage	Ui	VAC	250	250	250	
Rated impulse withstand voltage	Uimp	kV	4	4	4	
Thermal current	Ith/Ithe	A	20	32	40	
Rated operational current - Ie	AC22A Mixed resistive and inductive loads, including moderate overloads	250V	A	20	32	40
	AC23A Switching of motor loads or other highly inductive loads	250V	A	20	32	40
Rated short time withstand current	Icw (1s)	A	480	480	480	
Conditional short circuit current		kAeff	10	10	10	
Associate fuse size for conditional short circuit current - Type gG		A	20	32	40	
Flexible wire		mm ²	6	6	6	
Rigid wire		mm ²	6	6	6	

■ TECHNICAL CHARACTERISTICS 2P, 3P, 3P+SN, 3P+N, 4P

Switch size			Y1				Y4			Y5		
Rated current In			16A	20A	32A	40A	63A	80A	100A	125A	160A	
Rated insulation voltage	Ui	VAC	690	690	690	690	800	800	800	800	800	
Rated impulse withstand voltage	Uimp	kV	4	4	4	4	8	8	8	8	8	
Thermal current	Ith/Ithe	A	16	20	32	40	63	80	100	125	160	
Rated operational current - Ie	AC21A Resistive loads, including moderate overloads	415V	A	16	20	32	40	63	80	100	125	160
		500V	A	16	20	32	32	63	80	100	125	160
		690V	A	16	20	32	32	63	80	100	125	160
	AC22A Mixed resistive and inductive loads, including moderate overloads	415V	A	16	20	32	40	63	80	100	125	160
		500V	A	16	20	32	32	63	80	100	125	160
		690V	A	16	20	32	32	63	80	100	125	160
	AC23A Switching of motor loads or other highly inductive loads (3 phase / 3 pole)	415V	A	16	20	32	35	63	80	100	125	160
		500V	A	16	20	25	25	63	63	63	125	125
		690V	A	16	20	25	25	63	63	63	100	100
	AC23A Rated operational power (°)	415V	Kw	7.5	9	15	18.5	33	37	46	55	69
	AC3 Squirrel-cage motor: starting, switching off motor during running (3 phase / 3 pole)	415V	A	18	18	25	28.5	40	55	-	-	-
		690V	A	-	12	18	20	25	32	-	-	-
DC22A Mixed resistive and inductive loads, including moderate overloads	250V	A	-	25(*)	32(*)	32(*)	-	-	-	-	-	
	600V	A	-	10(*)	10(*)	10(*)	-	-	-	-	-	
Rated short time withstand current	Icw (1s)	A	400	400	400	400	1500	1500	1500	3000	3000	
Conditional short circuit current		kAeff	10	10	10	10	10	10	30	50	50	
Associate fuse size for conditional short circuit current - Type gG		A	16	20	32	40	63	80	100	125	125	
Flexible wire		mm ²	1.5-10	1.5-10	1.5-10	1.5-10	10-35	10-35	10-50	10-70	10-70	
Rigid wire		mm ²	1.5-16	1.5-16	1.5-16	1.5-16	10-35	10-35	10-50	10-70	10-70	

(*) Only 4P with 2+2 poles in series.

(°) This values are given for guidance and may vary according to the specifics provided by the motor manufacturer.

■ TECHNICAL CHARACTERISTICS 6P, 8P

Switch size			Y3				Y4			Y5		
Rated current I _n			16A	25A	32A	40A	63A	80A	100A	125A	160A	
Rated insulation voltage	U_i	VAC	800	800	800	800	800	800	800	800	800	
Rated impulse withstand voltage	U_{imp}	kV	8	8	8	8	8	8	8	8	8	
Thermal current	I_{th}/I_{the}	A	16	25	32	40	63	80	100	125	160	
Rated operational current – I _e	AC21A Resistive loads, including moderate overloads	415V	A	16	25	32	40	63	80	100	125	160
		500V	A	16	25	32	40	63	80	100	125	160
		690V	A	16	25	32	40	63	80	100	125	160
	AC22A Mixed resistive and inductive loads, including moderate overloads	415V	A	16	25	32	40	63	80	100	125	160
		500V	A	16	25	32	40	63	80	100	125	160
		690V	A	16	25	32	40	63	80	100	125	160
	AC23A Switching of motor loads or other highly inductive loads (3 phase / 3 pole)	415V	A	16	25	32	40	63	80	100	125	160
		500V	A	16	25	32	40	63	63	63	125	125
		690V	A	16	25	25	25	32	32	32	100	100
	AC23A Rated operational power (°)	415V	kW	7,5	11	15	18,5	35	37	46	55	69
	Rated short time withstand current	I_{cs} (1s)	A	1100	1100	1100	1100	1500	1500	1500	3000	3000
	Conditional short circuit current		kA _{eff}	50	50	50	50	50	50	30	50	50
Associate fuse size for conditional short circuit current - Type gG		A	16	25	32	40	63	80	100	125	125	
Flexible wire		mm ²	4-25	4-25	4-25	4-25	10-50	10-50	10-50	10-70	10-70	
Rigid wire		mm ²	4-25	4-25	4-25	4-25	10-50	10-50	10-50	10-70	10-70	

(°) This values are given for guidance and may vary according to the specifics provided by the motor manufacturer.

ISOLATORS-INOX Series

Switch disconnectors - Stainless steel enclosure





■ SURFACE MOUNTING - IP65
16A ÷ 40A - 1P+SN, 2P, 3P, 3P+SN, 3P+N, 6P, 8P

ISOLATORS-INOX Series

100x160x90 mm

250x280x120 mm



	Poles	Switch size	☒	100x160x90 mm		250x280x120 mm	
				EMERGENCY SWITCHING 	GENERAL USE 	EMERGENCY SWITCHING 	GENERAL USE 
16A	6P	Y3	1/5			590.SEM1606	590.SGE1606
	1P+SN			590.SEM2002.SN	590.SGE2002.SN		
	2P			590.SEM2002	590.SGE2002		
20A	3P	Y1	1/5	590.SEM2003	590.SGE2003		
	3P+SN			590.SEM2005.SN	590.SGE2005.SN		
	3P+N			590.SEM2005	590.SGE2005		
25A	6P	Y3	1/5			590.SEM2506	590.SGE2506
	8P					590.SEM2508	590.SGE2508
	1P+SN			590.SEM3202.SN	590.SGE3202.SN		
	2P			590.SEM3202	590.SGE3202		
	3P	Y1	1/5	590.SEM3203	590.SGE3203		
32A	3P+SN			590.SEM3205.SN	590.SGE3205.SN		
	3P+N			590.SEM3205	590.SGE3205		
	6P	Y3	1			590.SEM3206	590.SGE3206
	8P					590.SEM3208	590.SGE3208
	1P+SN			590.SEM4002.SN	590.SGE4002.SN		
	2P			590.SEM4002	590.SGE4002		
	3P	Y1	1/5	590.SEM4003	590.SGE4003		
40A	3P+SN			590.SEM4005.SN	590.SGE4005.SN		
	3P+N			590.SEM4005	590.SGE4005		
	6P	Y3	1			590.SEM4006	590.SGE4006
	8P					590.SEM4008	590.SGE4008

☒ Pack Quantity



- 3P+N with early make late break neutral pole.
- Enclosures with stand-off mounting brackets available on request.

- Equipped with door locking.

- Switch disconnectors units suitable as spare parts available in the General catalogue.
- 1P+SN / 3P+SN: unswitched neutral (solid neutral terminal block)

■ SURFACE MOUNTING - IP65
63A ÷ 160A - 3P, 3P+SN, 3P+N, 6P, 8P



ISOLATORS-INOX Series

		150x220x120 mm		250x280x120 mm		300x400x150 mm		
Poles	Switch size	□						
			EMERGENCY SWITCHING	GENERAL USE	EMERGENCY SWITCHING	GENERAL USE	EMERGENCY SWITCHING	GENERAL USE
63A	3P		590.SEM6303	590.SGE6303				
	3P+SN	1/5	590.SEM6305.SN	590.SGE6305.SN				
	3P+N	Y4	590.SEM6305	590.SGE6305				
	6P				590.SEM6306	590.SGE6306		
	8P	1			590.SEM6308	590.SGE6308		
80A	3P		590.SEM8003	590.SGE8003				
	3P+SN	1/5	590.SEM8005.SN	590.SGE8005.SN				
	3P+N	Y4	590.SEM8005	590.SGE8005				
	6P				590.SEM8006	590.SGE8006		
	8P	1			590.SEM8008	590.SGE8008		
100A	3P		590.SEM10003	590.SGE10003				
	3P+SN	1/5	590.SEM10005.SN	590.SGE10005.SN				
	3P+N	Y4	590.SEM10005	590.SGE10005				
	6P				590.SEM10006	590.SGE10006		
	8P	1			590.SEM10008	590.SGE10008		
125A	3P						590.SEM12503	590.SGE12503
	3P+SN						590.SEM12505.SN	590.SGE12505.SN
	3P+N	Y5	1				590.SEM12505	590.SGE12505
	6P						590.SEM12506	590.SGE12506
	8P						590.SEM12508	590.SGE12508
160A	3P						590.SEM16003	590.SGE16003
	3P+SN						590.SEM16005.SN	590.SGE16005.SN
	3P+N	Y5	1				590.SEM16005	590.SGE16005
	6P						590.SEM16006	590.SGE16006
	8P						590.SEM16008	590.SGE16008

□ Pack Quantity

- 3P+N with early make late break neutral pole.
- Enclosures with stand-off mounting brackets available on request.

- Equipped with door locking.
- Switch disconnectors units suitable as spare parts available in the General catalogue.
- 3P+SN: unswitched neutral (solid neutral terminal block)

	Padlockable handle in one position (OFF).
	Padlockable handle in two positions (ON/OFF).

ISOLATORS-HR Series

High rating switch disconnectors

HINGED SHEET STEEL /THERMOPLASTIC ENCLOSURE - 160A-1600A



ISOLATORS-HR is a line of disconnectors available from 160 up to 1600A, inserted in painted sheet steel enclosures with a hinged door.

The dimensions of the enclosures are particularly large to allow the connection of large diameter cables necessary for high power applications with long electrical lines.

The availability of versions with internal bars allows a linear connection from the bottom side of the panel without needing to bend the inbound and outbound line cables.

The load-break switches and disconnectors used are characterised by high electrical performance and high resistance to short circuits to satisfy the necessary requirements to establish, carry and interrupt high currents and withstand large short circuit currents.

REFERENCE STANDARDS

EN 60947-3

Low voltage switchgear and controlgear.
Part 3: switches, disconnectors, switch-disconnectors and fuse-combination unit.

EN 60529

Degrees of protection provided by enclosure.

TECHNICAL CHARACTERISTICS

Polarity:	3P, 3P+SN, 3P+N
Rated current:	160A-200A-250A-315A-400A 500A-630A-800A-1000A 1250A-1600A (*)
Protection degree:	IP65
Operating ambient temperature according to the reference standard:	-5°C +40°C
Min-Max. operating ambient temperature:	-25°C +60°C
Material:	Steel sheet/Thermoplastic
IK degree:	IK10
Finishing/colour:	Polyester powder grey RAL7032 (steel sheet) Grey RAL7035 (thermoplastic)

3P+N configuration:
- switched neutral (early make late break).
- unswitched neutral (solid neutral terminal block ".SN" suffix).
Padlockable handle.
Equipped with door locking.
Full current neutral pole up to 1250A.
(*) Neutral pole 1250A
Full current neutral pole available on request.

BEHAVIOUR WITH CHEMICAL AND ATMOSPHERIC AGENTS

Saline solution	Acids		Bases		Solvents				Mineral oil	UV rays
	Concentrated	Diluted	Concentrated	Diluted	Hexane	Benzol	Acetone	Alcohol		
Resistant	Limited Resistance	Resistant	Resistant	Resistant	Resistant	Resistant	Resistant	Resistant	Resistant	Resistant

Resistance values to chemical agents have to be considered indicative.
For further information and specific substances, contact the technical service.

Dimensional drawings: www.scame.com

■ CABLE INLETS
**Hinged sheet steel enclosure 3P, 3P+SN, 3P+N
Top/Bottom entries**

Rated current (A)	Nr of poles	Dimension (mm)	Cable entries	
			Top	Blank side
160-200-250	3P, 3P+SN, 3P+N	300x500x200	Top	Blank side
			Bottom	Gland plate
315-400	3P, 3P+SN, 3P+N	400x600x200	Top	Blank side
			Bottom	Gland plate
500-630	3P, 3P+SN, 3P+N	500x700x250	Top	Blank side
			Bottom	Gland plate
800-1000 1250-1600	3P, 3P+SN, 3P+N	600x1000x300	Top	Blank side
			Bottom	Gland plate

■ CABLE INLETS
**Hinged sheet steel enclosure 3P, 3P+SN, 3P+N
Bottom/Bottom entries**

Rated current (A)	Nr of poles	Dimension (mm)	Cable entries	
			Top	Blank side
160-200-250	3P, 3P+SN, 3P+N	300x500x200	Top	Blank side
			Bottom	Gland plate
315-400	3P, 3P+SN, 3P+N	400x600x200	Top	Blank side
			Bottom	Gland plate
500	3P, 3P+SN, 3P+N	500x700x250	Top	Blank side
			Bottom	Gland plate
630-800	3P, 3P+SN, 3P+N	800x800x300	Top	Blank side
			Bottom	Gland plate
1000-1250 1600	3P, 3P+SN, 3P+N	1000x1000x300	Top	Blank side
			Bottom	Gland plate

■ CABLE INLETS
**Hinged sheet steel enclosure 6P, 8P
Top/Bottom entries**

Rated current (A)	Nr of poles	Dimension (mm)	Cable entries	
			Top	Blank side
100-125	6P, 8P	400x500x200	Top	Blank side
			Bottom	Gland plate
160	6P, 8P	500x700x250	Top	Blank side
			Bottom	Gland plate
200-250	6P, 8P	600x800x300	Top	Blank side
			Bottom	Gland plate
315-400-500	6P, 8P	800x800x300	Top	Blank side
			Bottom	Gland plate
630	6P, 8P	1000x1000x300	Top	Blank side
			Bottom	Gland plate

CONNECTIONS
BOTTOM/BOTTOM entries

Equipped with an insulated bar system which allows the wiring both incoming and outgoing cables from the bottom side without cable bending.

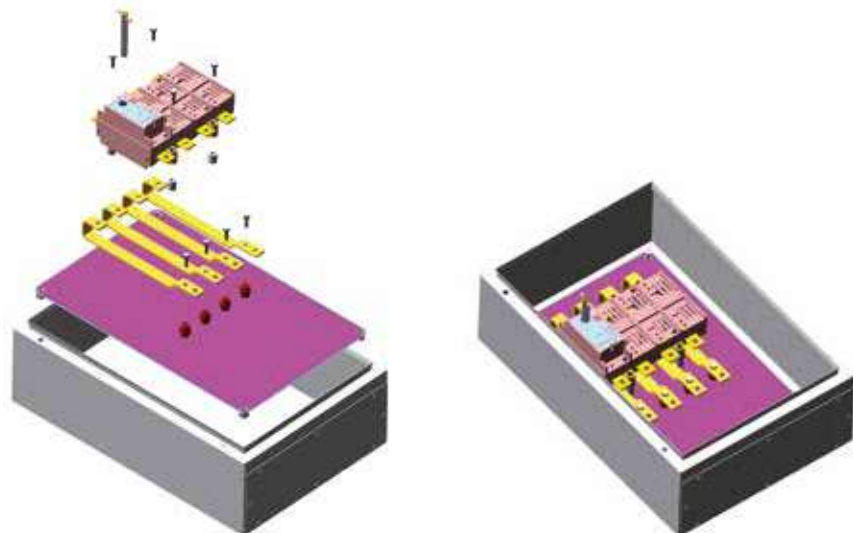

ISOLATORS-HR Series

High rating switch disconnectors

■ TECHNICAL CHARACTERISTICS 3P, 3P+SN, 3P+N, 6P, 8P

Switch size			K2			K3			K4	K5			K6	
Rated current In			160	200	250	315	400	500	630	800	1000	1250	1600(*)	
Rated insulation voltage	Ui	(V)	1000	1000	1000	1000	1000	1000	1000	1000	1000	1000	1000	
Rated impulse withstand voltage	Uimp	(kV)	12	12	12	12	12	12	12	12	12	12	12	
Thermal current	Ith/Ithe	(A)	160	200	250	315	400	500	800	800	1000	1250	1600	
Rated operational current – Ie	AC21A/B Resistive loads, including moderate overloads	415V (A)	160	200	250	315	400	500	630/800	800	1000	1250	1600	
		500V (A)	160	200	250	315	400	500	630/800	800	1000	1250	1600	
		690V (A)	160	200	250	315	400	500	630/800	800	1000	1250	1250	
	AC22A/B Mixed resistive and inductive loads, including moderate overloads	415V (A)	160	200	250	315	400	500	630/800	800	1000	1250	1600	
		500V (A)	160	200	250	315	400	400	630	800	1000	1250	1250	
		690V (A)	160	200	250	315	400	400	630	800	1000	1250	400	
	AC23A/B Switching of motor loads or other highly inductive loads (3 phase / 3 pole)	415V (A)	160	200	250	315	400	500	630	800	1000	1250	1250	
		500V (A)	125	160	200	250	315	315	500	800	800	800	800	
		690V (A)	100	125	160	200	250	250	400	400	400	400	400	
	AC23A Rated operational power (°)	415V kW	85	105	130	165	200	210	330	420	525	600	630	
	Rated making capacity	415V AC23	(A)	1600	2000	2500	3150	4000	4000	6300	6300	6300	6300	6300
	Rated breaking capacity	415V AC23	(A)	1280	1600	2000	2520	3200	3200	5040	5040	5040	5040	5040
Short circuit withstand current 1sec		(kA)	8	8	8	13	13	13	26.5	35	35	35	60	
Short circuit withstand current 0.25 sec		(kA)	16	16	16	26	26	26	53	70	70	70	120	
Short circuit making capacity	415V	(kA)	13.5	13.5	13.5	26	26	26	30	73.5	73.5	73.5	105	
Rated fuse short-circuit current	Back up fuse	(A)	160	200	250	315	400	400	630	800	1000	1000	-	
	R.M.S value	(kA)	50	50	50	50	50	50	50	100	100	100	-	
	Peak value	(kA)	16	20	25	25	30	30	40	70	90	100	-	
Terminal bolt size		mm ²	M8	M8	M8	M10	M10	M10	M12	M16	M16	M16	2xM14	
Palm width		mm	21	21	21	25	25	25	30	50	50	50	60	

(*) Neutral pole 1250A

Full current neutral pole available on request.

(°) This values are given for guidance and may vary according to the specifics provided by the motor manufacturer.

■ AUXILIARY CONTACTS

Switch size		590.PL00400x	590.PL005	590.PL0060xx
Rated thermal current	400V	16A	10A	10A
	250V	16A	16A	16A
Rated operational current AC15	400V	4.5A	-	-
	250V	6A	1A	1A

Break before main contacts.

High rating switch disconnectors - Hinged sheet steel enclosure



■ SURFACE MOUNTING - IP65 100A ÷ 1600A - 3P, 3P+SN, 3P+N, 6P, 8P - TOP/BOTTOM CONNECTION

ISOLATORS-HR Series

300x500x200 mm

400x500x200 mm

600x800x300 mm



Poles	Switch size	□	300x500x200 mm		400x500x200 mm		600x800x300 mm	
			EMERGENCY SWITCHING	GENERAL USE	EMERGENCY SWITCHING	GENERAL USE	EMERGENCY SWITCHING	GENERAL USE
100A	6P	K2	1		590.KEM10006	590.KGE10006		
	8P				590.KEM10008	590.KGE10008		
125A	6P	K2	1		590.KEM12506	590.KGE12506		
	8P				590.KEM12508	590.KGE12508		
160A	3P	K2	1	590.KEM16003	590.KGE16003			
	3P+SN			590.KEM16005.SN	590.KGE16005.SN			
	3P+N			590.KEM16005	590.KGE16005			
	6P						590.KEM16006	590.KGE16006
	8P						590.KEM16008	590.KGE16008
200A	3P	K2	1	590.KEM20003	590.KGE20003			
	3P+SN			590.KEM20005.SN	590.KGE20005.SN			
	3P+N			590.KEM20005	590.KGE20005			
	6P						590.KEM20006	590.KGE20006
	8P						590.KEM20008	590.KGE20008
250A	3P	K2	1	590.KEM25003	590.KGE25003			
	3P+SN			590.KEM25005.SN	590.KGE25005.SN			
	3P+N			590.KEM25005	590.KGE25005			
	6P						590.KEM25006	590.KGE25006
	8P						590.KEM25008	590.KGE25008

□ Pack Quantity

- 3P+N with early make late break neutral pole.
- Enclosures with stand-off mounting brackets available on request.

- Equipped with door locking.
- Switch disconnectors units suitable as spare parts available in the General catalogue.
- 3P+SN: unswitched neutral (solid neutral terminal block)

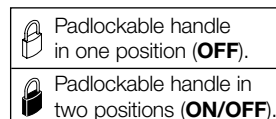

ISOLATORS-HR Series

High rating switch disconnectors - Hinged sheet steel enclosure

■ SURFACE MOUNTING - IP65

100A ÷ 1600A - 3P, 3P+SN, 3P+N, 6P, 8P - TOP/BOTTOM CONNECTION

ISOLATORS-HR Series

		400x600x200 mm		500x700x250 mm		800x800x300 mm	
Poles	Switch size	EMERGENCY SWITCHING	GENERAL USE	EMERGENCY SWITCHING	GENERAL USE	EMERGENCY SWITCHING	GENERAL USE
315A	3P	590.KEM31503	590.KGE31503				
	3P+SN	590.KEM31505.SN	590.KGE31505.SN				
	3P+N	590.KEM31505	590.KGE31505				
	6P					590.KEM31506	590.KGE31506
	8P					590.KEM31508	590.KGE31508
400A	3P	590.KEM40003	590.KGE40003				
	3P+SN	590.KEM40005.SN	590.KGE40005.SN				
	3P+N	590.KEM40005	590.KGE40005				
	6P					590.KEM40006	590.KGE40006
	8P					590.KEM40008	590.KGE40008
500A	3P			590.KEM50003	590.KGE50003		
	3P+SN			590.KEM50005.SN	590.KGE50005.SN		
	3P+N			590.KEM50005	590.KGE50005		
	6P					590.KEM50006	590.KGE50006
	8P					590.KEM50008	590.KGE50008

□ Pack Quantity

- 3P+N with early make late break neutral pole.
- Enclosures with stand-off mounting brackets available on request.

- Equipped with door locking.

- Switch disconnectors units suitable as spare parts available in the General catalogue.
- 3P+SN: unswitched neutral (solid neutral terminal block)

SURFACE MOUNTING - IP65
100A ÷ 1600A - 3P, 3P+N, 6P, 8P - TOP/BOTTOM CONNECTION

ISOLATORS-HR Series

500x700x250 mm

600x1000x300 mm

1000x1000x300 mm



Poles	Switch size	□	500x700x250 mm		600x1000x300 mm		1000x1000x300 mm	
			EMERGENCY SWITCHING	GENERAL USE	EMERGENCY SWITCHING	GENERAL USE	EMERGENCY SWITCHING	GENERAL USE
630A	3P	K4	1	590.KEM63003	590.KGE63003			
	3P+SN			590.KEM63005.SN	590.KGE63005.SN			
	3P+N			590.KEM63005	590.KGE63005			
	6P					590.KEM63006	590.KGE63006	
	8P					590.KEM63008	590.KGE63008	
800A	3P	K5	1			590.KEM80003	590.KGE80003	
	3P+SN					590.KEM80005.SN	590.KGE80005.SN	
	3P+N					590.KEM80005	590.KGE80005	
1000A	3P	K5	1			590.KEM100003	590.KGE100003	
	3P+SN					590.KEM100005.SN	590.KGE100005.SN	
	3P+N					590.KEM100005	590.KGE100005	
1250A	3P	K5	1			590.KEM125003	590.KGE125003	
	3P+SN					590.KEM125005.SN	590.KGE125005.SN	
	3P+N					590.KEM125005	590.KGE125005	
1600A	3P	K6	1			590.KEM160003	590.KGE160003	
	3P+SN					590.KEM160005.SN	590.KGE160005.SN	
	3P+N					590.KEM160005	590.KGE160005	

□ Pack Quantity

- 3P+N with early make late break neutral pole.
- Enclosures with stand-off mounting brackets available on request.

- Equipped with door locking.
- Switch disconnectors units suitable as spare parts available in the General catalogue.
- 3P+SN: unswitched neutral (solid neutral terminal block)

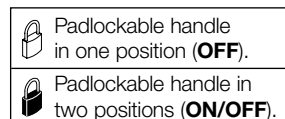

ISOLATORS-HR Series

High rating switch disconnectors - Thermoplastic enclosure

■ SURFACE MOUNTING - IP65
160A ÷ 250A - 3P, 3P+SN, 3P+N - TOP/BOTTOM CONNECTION

ISOLATORS-HR Series

464x519x245 mm



	Poles	Switch size	□	EMERGENCY SWITCHING		GENERAL USE	
				■	■	■	■
160A	3P	K2	1	590.EM16013		590.GE16013	
	3P+SN			590.EM16015.SN		590.GE16015.SN	
	3P+N			590.EM16015		590.GE16015	
200A	3P	K2	1	590.EM20003		590.GE20003	
	3P+SN			590.EM20005.SN		590.GE20005.SN	
	3P+N			590.EM20005		590.GE20005	
250A	3P	K2	1	590.EM25003		590.GE25003	
	3P+SN			590.EM25005.SN		590.GE25005.SN	
	3P+N			590.EM25005		590.GE25005	

□ Pack Quantity

- 3P+N with early make late break neutral pole.
- Equipped with door locking.

- Switch disconnectors units suitable as spare parts available in the General catalogue.
- 3P+SN: unswitched neutral (solid neutral terminal block)

High rating switch disconnectors - Hinged sheet steel enclosure



■ SURFACE MOUNTING - IP65 160A ÷ 1600A - 3P, 3P+SN, 3P+N - BOTTOM/BOTTOM CONNECTION

ISOLATORS-HR Series

300x500x200 mm 400x600x200 mm 500x700x250 mm 800x800x300 mm 1000x1000x300 mm



Poles	Switch size	□	GENERAL USE				
			300x500x200 mm	400x600x200 mm	500x700x250 mm	800x800x300 mm	1000x1000x300 mm
160A	3P		590.KGE16003B				
	3P+SN	K2	1	590.KGE16005B.SN			
	3P+N			590.KGE16005B			
200A	3P		590.KGE20003B				
	3P+SN	K2	1	590.KGE20005B.SN			
	3P+N			590.KGE20005B			
250A	3P		590.KGE25003B				
	3P+SN	K2	1	590.KGE25005B.SN			
	3P+N			590.KGE25005B			
315A	3P			590.KGE31503B			
	3P+SN	K3	1	590.KGE31505B.SN			
	3P+N			590.KGE31505B			
400A	3P			590.KGE40003B			
	3P+SN	K3	1	590.KGE40005B.SN			
	3P+N			590.KGE40005B			
500A	3P				590.KGE50003B		
	3P+SN	K3	1		590.KGE50005B.SN		
	3P+N				590.KGE50005B		
630A	3P					590.KGE63003B	
	3P+SN	K4	1			590.KGE63005B.SN	
	3P+N					590.KGE63005B	
800A	3P					590.KGE80003B	
	3P+SN	K5	1			590.KGE80005B.SN	
	3P+N					590.KGE80005B	
1000A	3P						590.KGE100003B
	3P+SN	K5	1				590.KGE100005B.SN
	3P+N						590.KGE100005B
1250A	3P						590.KGE125003B
	3P+SN	K5	1				590.KGE125005B.SN
	3P+N						590.KGE125005B
1600A (*)	3P						590.KGE160003B
	3P+SN	K6	1				590.KGE160005B.SN
	3P+N						590.KGE160005B

- Pack Quantity
- 3P+N with early make late break neutral pole.
 - Equipped with door locking.
 - Emergency switch on request.
 - Full current neutral pole up to 1250A.

- (*) Neutral pole 1250A.
- Full current neutral pole available on request.
- Busbar system
- 3P+SN: unswitched neutral (solid neutral terminal block)

Padlockable handle in one position (OFF).

Padlockable handle in two positions (ON/OFF).

ISOLATORS-PH Series

DC switch disconnectors for photovoltaic applications

■ THERMOPLASTIC INSULATED ENCLOSURE - 15A-160A (800V DC)



Scame embraces completely the renewable energy sources philosophy and the respect for the environment.

In our production plant and office building we have installed 250kWp of photovoltaic system. We follow up this field in several countries with a wide range of products.

From our experience is born the new range of DC Isolators specific for photovoltaic systems.

In according to the IEC 60364-7-712, in every photovoltaic installation it is necessary to isolate the photovoltaic panel from the rest of the system, DC Isolators must have a higher performance than the traditional AC Isolators because breaking direct current is more difficult than breaking alternating current, and furthermore in a photovoltaic system the voltage can reach even 800V.

The current and voltage values changes depending on the combination of the photovoltaic cells.

DC Isolator range has been set up focusing on all of the main photovoltaic installations in order to get a range as essential as possible, simplify the choice of the customer and for have the maximum quality and technical characteristics.

In the meantime we are improving and up grading constantly our products, following and anticipating the change that the market requires due to the incentives available. Scame ISOLATORS Series includes also a complete range of AC Isolators, essential to make a photovoltaic system in compliance with IEC 60364-7-712.

Finally in the photovoltaic range it is available a huge range of water tight cabinets and consumer unit suitable for make distribution board & export control.

■ REFERENCE STANDARDS

EN 60947-3

Low voltage switchgear and controlgear.
Part 3: switches, disconnectors, switch-disconnectors and fuse-combination unit.

IEC 60364-7-712

Requirements for special installations or locations
Solar photovoltaic (RV) power supply systems.

EN 60529

Degrees of protection provided by enclosure.

■ TECHNICAL CHARACTERISTICS

Poles in series:	4P, 5P, 6P, 8P
Rated current (800V):	15A-16A-20A-25A-30A-40A
Protection degree:	IP65
Operating ambient temperature according to the reference standard:	-5°C +40°C
Min-Max. operating ambient temperature:	-25°C +60°C
IK degree:	IK08
Material:	Thermoplastic
Insulation class:	Class II (double insulation) □
Glow wire test:	650°C (enclosure) 850°C (switch)

■ BEHAVIOUR WITH CHEMICAL AND ATMOSPHERIC AGENTS

Saline solution	Acids		Bases		Solvents				Mineral oil	UV rays
	Concentrated	Diluted	Concentrated	Diluted	Hexane	Benzol	Acetone	Alcohol		
Resistant	Limited Resistance	Resistant	Resistant	Resistant	Not Resistant	Not Resistant	Not Resistant	Limited Resistance	Limited Resistance	Resistant

Resistance values to chemical agents have to be considered indicative.

For further information and specific substances, contact the technical service.

Dimensional drawings: www.scame.com

■ **CABLE INLETS**

Photovoltaic/DC switch disconnectors thermoplastic insulated enclosure 4P, 5P, 6P, 8P

Rated current (A)	Rated voltage (V DC)	Nr of poles in series	Enclosure dimensions (mm)	Cable entries		
16	450	4P	110x150x86	Top/Bottom	2xM25	Knock-outs/Blank side
				Rear	1xM25	Knock-outs/Blank side
15-20	800	4P, 5P	105x150x100	Top	-	Blank side (°)
				Bottom	-	Blank side (°)
				Rear	-	Blank side (°)
25-30	800	6P, 8P	160x220x114	Top/Bottom	2xM32	Knock-outs/Blank side
				Rear	2xM32	Knock-outs/Blank side
40	800	8P	228x308x128	Top	-	Blank side (°)
				Bottom	-	Blank side (°)

(°) Perforated or threaded entries on request.

APPLICATION EXAMPLE



ISOLATORS-PH Series

DC switch disconnectors for photovoltaic applications

■ TECHNICAL CHARACTERISTICS 4P, 5P, 6P, 8P

Switch size		D1	D3				D5		
Rated current I _n		16A	15A	20A	25A	30A	40A		
Rated insulation voltage	U_i	VAC	690	1500	1500	1500	1500		
Rated impulse withstand voltage	U_{imp}	kV	4	8	8	8	8		
Thermal current	I_{th}/I_{the}	A	30	63	63	63	125		
Number of poles in series		4	4	5	6	8	8		
Rated operational current – I _e	DC21A Resistive loads, including moderate overloads	300V DC	A	32	-	-	-	-	
		400V DC	A	-	30	35	40	60	80
		450V DC	A	16	-	-	-	-	-
		500V DC	A	-	30	35	40	45	65
		600V DC	A	-	20	25	40	40	60
		750V DC	A	-	15	20	25	30	40
		800V DC	A	-	15	20	25	30	40
Rated short time withstand current	I_{cw} (1s)	A	400	1100	1100	1100	1100	3000	
Flexible wire		mm ²	1.5-10	16	16	16	16	70	
Rigid wire		mm ²	1.5-10	16	16	35	16	70	

■ POSSIBLE CONTACT WIRINGS

SWITCH LINKING

In order to make easier the work of the installer, it is possible to choose the manner of wiring of the poles in series. In this way the incoming and

the outgoing can be varied both on the top side and on the bottom side. In the packaging jumpers are supplied to cover the chosen configuration.

590.DCGE0815 - 590.DCGE0416 - (4 POLES IN SERIES) - 3 JUMPERS SUPPLIED

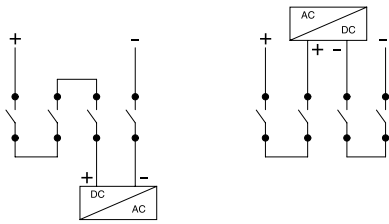

590.DCGE0820 - (5 POLES IN SERIES) - 4 JUMPERS SUPPLIED

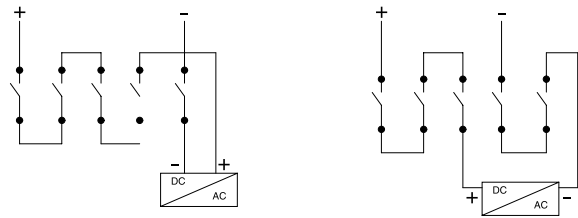

590.DCGE0825 - (6 POLES IN SERIES) - 5 JUMPERS SUPPLIED

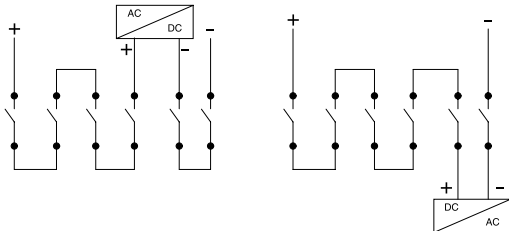

590.DCGE0830 - 590.DCGE0840 - (8 POLES IN SERIES) - 8 JUMPERS SUPPLIED

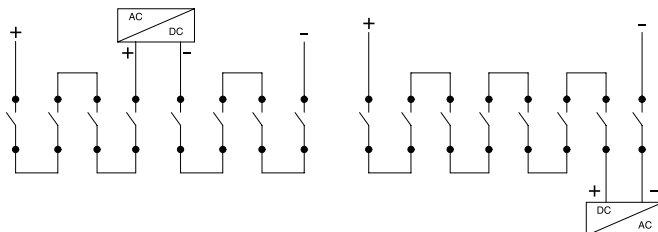

DC switch disconnectors for photovoltaic applications - Thermoplastic enclosure



■ SURFACE MOUNTING - IP65
15A ÷ 40A

ISOLATORS-PH Series

110x150x86 mm 105x150x100 mm 160x220x114 mm 228x308x128 mm



	Rated voltage (V)	Poles in series	Switch size		GENERAL USE	GENERAL USE	GENERAL USE	GENERAL USE
16A	450	4P	D1	1/12	590.DCGE0416			
15A	800	4P	D3	1/12		590.DCGE0815		
20A	800	5P	D3	1/12		590.DCGE0820		
25A	800	4P	D3	1/12			590.DCGE0825	
30A	800	4P	D3	1/12			590.DCGE0830	
40A	800	4P	D5	1/12				590.DCGE0840

Pack Quantity

- Switch disconnectors units suitable as spare parts available in the General catalogue.

- Padlockable handle in one position (**OFF**).
- Padlockable handle in two positions (**ON/OFF**).

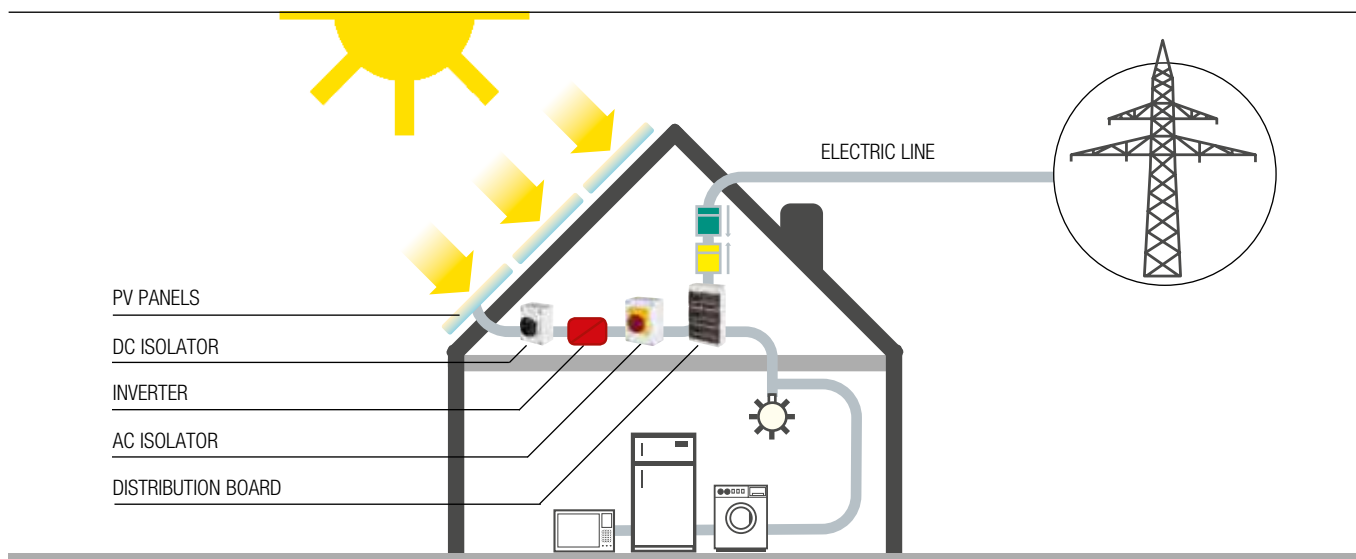

ISOLATORS-HD Series

[HD] Switch disconnectors

HEAVY DUTY ENGINEERING PLASTIC INSULATED ENCLOSURE - 20A-40A



The technopolymer used for Heavy Duty Isolators guarantees an excellent heat and fire resistance: Glow Wire 960°C according to EN 60695-2-1; 5VA according to UL94.

This material guarantees an excellent mechanical resistance to impacts. The impact resistance of the casings is higher than 20J (IK10) according to EN50102, even under limit temperature conditions (-40°C +60°C).

The structure and materials used also make ISOLATORS-HD a product suited for the most extreme environmental conditions. The special silicon gasket and the IP66 degree guarantees an excellent seal against the entry of solid objects or liquids into the casings even after a long term installation. Outstanding resistance to UV radiation, exceptional reliability under environmental stress and use at both low and high ambient temperatures (-40°C +60°C).

REFERENCE STANDARDS

EN 60947-3

Low voltage switchgear and controlgear.
Part 3: switches, disconnectors, switch-disconnectors and fuse-combination unit.

EN 60529

Degrees of protection provided by enclosure.

TECHNICAL CHARACTERISTICS

Polarity:	2P, 3P, 3P+N
Rated current:	20A-32A-40A
Protection degree:	IP66
Operating ambient temperature according to the reference standard:	-5°C +40°C
Min-Max. operating ambient temperature:	-40°C +60°C
Material:	High performance engineering thermoplastic
IK degree:	IK10
Glow wire test:	960°C (enclosure and switch)
Self extinguishing UL94:	5VA
Colour:	Grey RAL7004
Insulation class:	Class II (double insulation) □

3P+N with early make late break neutral pole.
Padlockable handle.
Equipped with door locking.

BEHAVIOUR WITH CHEMICAL AND ATMOSPHERIC AGENTS

Saline solution	Acids		Bases		Solvents				Mineral oil	UV rays
	Concentrated	Diluted	Concentrated	Diluted	Hexane	Benzol	Acetone	Alcohol		
Resistant	Limited Resistance	Resistant	Resistant	Resistant	Not Resistant	Not Resistant	Not Resistant	Limited Resistance	Limited Resistance	Resistant

Resistance values to chemical agents have to be considered indicative.
For further information and specific substances, contact the technical service.

Dimensional drawings: www.scame.com

■ CABLE INLETS

Heavy duty engineering plastic insulated enclosure 2P, 3P, 3P+N

Rated current (A)	Nr of poles	Enclosure dimensions (mm)	Cable entries		
			Top	Bottom	Rear
20-32-40	2P, 3P, 3P+N	115x190x128	Top	-	Blank side (*)
			Bottom	-	Blank side (*)
			Rear	-	Blank side (*)

(*) Perforated or threaded entries on request.

APPLICATION EXAMPLE



ISOLATORS-HD Series

Switch disconnectors

■ TECHNICAL CHARACTERISTICS 2P, 3P, 3P+N

Switch size			Y1			
Rated current In			20A	32A	40A	
Rated insulation voltage	Ui	VAC	690	690	690	
Rated impulse withstand voltage	Uimp	kV	4	4	4	
Thermal current	Ith/lthe	A	20	32	40	
Rated operational current – Ie	AC21A Resistive loads, including moderate overloads	415V	A	20	32	40
		500V	A	20	32	32
		690V	A	20	32	32
	AC22A Mixed resistive and inductive loads, including moderate overloads	415V	A	20	32	40
		500V	A	20	32	32
		690V	A	20	32	32
	AC23A Switching of motor loads or other highly inductive loads (3 phase / 3 pole)	415V	A	20	32	35
		500V	A	20	25	25
		690V	A	20	25	25
	AC23A Rated operational power (°)	415V	Kw	9	15	18.5
	AC3 Squirrel-cage motor: starting, switching off motor during running (3 phase / 3 pole)	415V	A	18	25	28.5
		690V	A	12	18	20
	DC22A Mixed resistive and inductive loads, including moderate overloads	250V	A	25(*)	32(*)	32(*)
		600V	A	10(*)	10(*)	10(*)
Rated short time withstand current	Icw (1s)	A	400	400	400	
Conditional short circuit current		kAeff	10	10	10	
Associate fuse size for conditional short circuit current - Type gG		A	20	32	40	
Flexible wire		mm ²	1.5-10	1.5-10	1.5-10	
Rigid wire		mm ²	1.5-16	1.5-16	1.5-16	

(*) Only 4P with 2+2 poles in series.

(°) This values are given for guidance and may vary according to the specifics provided by the motor manufacturer.

Switch disconnectors - [IP66] Heavy duty thermoplastic insulated enclosure



■ **SURFACE MOUNTING - IP66**
20A ÷ 40A - 2P, 3P, 3P+N

ISOLATORS-HD Series

115x190x128 mm



	Poles	Switch size	□		
				EMERGENCY SWITCHING	GENERAL USE
20A	2P	Y1	1/12	590.JEM2002	590.JGE2002
	3P			590.JEM2003	590.JGE2003
	3P+N			590.JEM2005	590.JGE2005
32A	2P	Y1	1/12	590.JEM3202	590.JGE3202
	3P			590.JEM3203	590.JGE3203
	3P+N			590.JEM3205	590.JGE3205
40A	2P	Y1	1/12	590.JEM4002	590.JGE4002
	3P			590.JEM4003	590.JGE4003
	3P+N			590.JEM4005	590.JGE4005

□ Pack Quantity

- 3P+N with early make late break neutral pole.
- Equipped with door locking.
- Switch disconnectors units suitable as spare parts available in the General catalogue.

ISOLATORS-HD SERIES [IP66]

	Padlockable handle in one position (OFF).
	Padlockable handle in two positions (ON/OFF).

ISOLATORS Series

Switch disconnectors with fuses

■ THERMOPLASTIC/ALUMINIUM/HINGED SHEET STEEL ENCLOSURE - 16A-630A



Completing the range of ISOLATORS are the versions with fuses, which offer a compact solution for protection against overloads and short circuits, in addition to the isolation and disconnection characteristics they share with the rest of the series.

Available with enclosures in thermoplastic up to 160A, in aluminium up to 80A, in sheet steel up to 630A, with the same characteristics in terms of IP and IK protection as the corresponding standard versions without fuses.

In the versions from 100 to 250A, the range also includes a version with internal bars to allow a linear connection from the bottom side of the panel without needing to bend the inbound and outbound line cables.

The load-break switches and disconnectors with fuses inside these ISOLATORS, have the same electrical characteristics as the rest of the range, with the additional option of being equipped with protective fuses.

■ REFERENCE STANDARDS

EN 60947-3

Low voltage switchgear and controlgear.
Part 3: switches, disconnectors, switch-disconnectors and fuse-combination unit.

EN 60529

Degrees of protection provided by enclosure.

■ TECHNICAL CHARACTERISTICS

Polarity:	2P, 3P, 3P+N, 4P (16A-32A) 3P, 3P+N (63A-80A-100A-125A- 160A-200A-250A-315A-400A-630A)
Rated voltage:	16A-32A-63A-80A-100A-125A- 160A-200A-250A-315A-400A-630A
Protection degree:	IP55 (thermoplastic) IP65 (aluminium/sheet steel)
Operating ambient temperature according to the reference standard:	-25°C +40°C
Max operating ambient temperature:	+60°C

3P+N with early make late break neutral pole.

Front operators box version equipped with door locking in ON position.

Padlockable handle.

ISOLATORS Series (Thermoplastic)

■ BEHAVIOUR WITH CHEMICAL AND ATMOSPHERIC AGENTS

Saline solution	Acids		Bases		Solvents				Mineral oil	UV rays
	Concentrated	Diluted	Concentrated	Diluted	Hexane	Benzol	Acetone	Alcohol		
Resistant	Limited Resistance	Resistant	Resistant	Resistant	Not Resistant	Not Resistant	Not Resistant	Limited Resistance	Limited Resistance	Resistant

Resistance values to chemical agents have to be considered indicative.

Dimensional drawings: www.scame.com

For further information and specific substances, contact the technical service.

■ CABLE INLETS

Thermoplastic insulated enclosure 2P, 3P, 3P+N, 4P

Rated current (A)	Nr of poles	Enclosure dimensions (mm)	Cable entries	
16-32	2P, 3P, 3P+N, 4P	240x190x125	Top	Blank side
			Bottom	Blank side
			Rear	Blank side
63-80	3P, 3P+N	380x300x170	Top	Blank side
			Bottom	Blank side
			Rear	Blank side
100-125-160	3P, 3P+N	450x370x180	Top	Blank side
			Bottom	Blank side
			Rear	Blank side

Perforated or threaded entries on request.

ISOLATORS Series (Aluminium)

■ BEHAVIOUR WITH CHEMICAL AND ATMOSPHERIC AGENTS

Saline solution	Acids		Bases		Solvents				Mineral oil	UV rays
	Concentrated	Diluted	Concentrated	Diluted	Hexane	Benzol	Acetone	Alcohol		
Resistant	Limited Resistance	Resistant	Limited Resistance	Limited Resistance	Resistant	Limited Resistance	Limited Resistance	Resistant	Resistant	Resistant

Resistance values to chemical agents have to be considered indicative.

Dimensional drawings: www.scame.com

For further information and specific substances, contact the technical service.

■ CABLE INLETS

Aluminium enclosure 2P, 3P, 3P+N, 4P

Rated current (A)	Nr of poles	Enclosure dimensions (mm)	Cable entries	
16-32	2P, 3P, 3P+N, 4P	253x217x93	Top	Blank side
			Bottom	Blank side
			Rear	Blank side
63-80	3P, 3P+N	410x315x128	Top	Blank side
			Bottom	Blank side
			Rear	Blank side

Perforated or threaded entries on request.

ISOLATORS Series

Switch disconnectors with fuses

ISOLATORS Series (Sheet steel)

■ BEHAVIOUR WITH CHEMICAL AND ATMOSPHERIC AGENTS

Saline solution	Acids		Bases		Solvents				Mineral oil	UV rays
	Concentrated	Diluted	Concentrated	Diluted	Hexane	Benzol	Acetone	Alcohol		
Resistant	Limited Resistance	Resistant	Resistant	Resistant	Resistant	Resistant	Resistant	Resistant	Resistant	Resistant

Resistance values to chemical agents have to be considered indicative.

Dimensional drawings: www.scame.com

For further information and specific substances, contact the technical service.

■ CABLE INLETS

Hinged sheet steel enclosure 3P, 3P+N top/bottom entries

Rated current (A)	Nr of poles	Enclosure dimensions (mm)	Cable entries	
			Top	Bottom
100-125	3P, 3P+N	300x500x200	Top	Gland plate
			Bottom	Gland plate
200-250	3P, 3P+N	400x600x200	Top	Gland plate
			Bottom	Gland plate
315-400	3P, 3P+N	500x700x250	Top	Gland plate
			Bottom	Gland plate
630	3P, 3P+N	600x800x300	Top	Gland plate
			Bottom	Gland plate

Perforated or threaded entries on request.

Hinged sheet steel enclosure 3P, 3P+N bottom/bottom entries

Rated current (A)	Nr of poles	Enclosure dimensions (mm)	Cable entries	
			Top	Bottom
100-125-160	3P, 3P+N	300x500x200	Top	Gland plate
			Bottom	Gland plate
200-250	3P, 3P+N	400x600x250	Top	Gland plate
			Bottom	Gland plate

Perforated or threaded entries on request.

■ TECHNICAL CHARACTERISTICS 2P, 3P, 3P+N, 4P

Switch size				F1		KF1		KF2		KF3		KF4		KF5	
Rated current In				16A	32A	63A	80A	100A	125A	160A	200A	250A	315A	400A	630A
Rated insulation voltage	Ui	VAC		690	690	1000	1000	1000	1000	1000	1000	1000	1000	1000	1000
		VDC		400	400	1500	1500	1500	1500	1500	1500	1500	1500	1500	1500
Rated impulse withstand voltage	Uimp	kV		4	4	8	8	12	12	12	12	12	12	12	12
Thermal current	Ith/Ithe	A		16	32	63	80	100	125	160	200	250	315	400	630
Rated operational current – Ie	AC21A Resistive loads, including moderate overloads	415V	A	16	32	63	80	100	125	160	200	250	315	400	630
		500V	A	16	32	63	80	100	125	160	200	250	315	400	630
		690V	A	16	32	63	80	100	125	160	200	250	315	400	630
	AC22A Mixed resistive and inductive loads, including moderate overloads	415V	A	16	32	63	80	100	125	160	200	250	315	400	630
		500V	A	16	32	63	80	100	125	160	200	250	315	400	630
		690V	A	16	32	63	80	100	125	160	200	250	315	400	630
	AC23A Switching of motor loads or other highly inductive loads (3 phase / 3 pole)	415V	A	16	32	63	80	100	125	160	200	250	315	400	630
		500V	A	16	32	45	63	80	100	125	160	200	250	315	500
		690V	A	16	25	32	45	63	80	100	125	160	200	250	400
	DC21A Resistive loads, including moderate overloads	220V	A	25	32	63	80	100	125	160	200	250	315	400	630
		400V	A	-	-	-	-	100	125	160	200	250	315	400	630
		600V	A	-	-	-	-	-	-	-	-	-	315	400	630
	DC22A Mixed resistive and inductive loads, including moderate overloads	220V	A	20	32	63	80	100	125	160	200	250	315	400	630
		400V	A	-	-	-	-	100	125	160	200	250	315	400	630
		600V	A	-	-	-	-	-	-	-	-	-	315	400	630
	DC23A Switching of highly inductive loads (e.g. series motors)	220V	A	-	-	50	50	100	125	160	160	160	250	250	400
400V		A	-	-	-	-	100	125	160	-	-	-	-	-	
Short circuit protection	Conditional short circuit current	KAeff		10	10	100	100	50	50	50	50	50	50	50	50
	Associate fuse size for conditional short circuit current	A		16	32	63	80	100	125	160	200	250	315	400	630
	Fuse type			gG	gG	DIN/BS	DIN/BS	DIN/BS	DIN/BS	DIN/BS	DIN/BS	DIN/BS	DIN/BS	DIN/BS	DIN/BS
Rated making capacity at 420V c.a.		A		160	320	630	800	1000	1250	1600	2000	2500	3150	4000	6300
Rated breaking capacity at 420V c.a.		A		128	256	504	640	800	1000	1280	1600	2000	2520	3200	5040
Cable section	Flexible wire	mm ²		1,5-10	1,5-10	25	25	70	70	70	120	120	240	240	2x185
		AWG		16-8	16-8										
	Bars	mm		-	-	12x3	12x3	16x4	16x4	16x4	25x4	25x4	32x5	32x5	2x40x6

■ FUSE LINKS SIZES

Ratings	16A	32A	63A	80A	100A	125A	160A	200A	250A	315A	400A	630A
DIN fuses Type	-	-	NH C00	NH C00	NH C00	NH 00	NH 00	NH 1	NH 1	NH 2	NH 2	NH 3
BS fuses Type	-	-	A2-A3	OSD	A4	DE0	DE0	B1-B2	B1-B3	B1-B3	B1-B4	C2
Cylindrical fuses (NF)	10X38	10X38	-	-	-	-	-	-	-	-	-	-

ISOLATORS Series

Switch disconnectors with fuses - Thermoplastic enclosure

■ SURFACE MOUNTING - IP55
16A ÷ 80A - 2P, 3P, 3P+N, 4P

ISOLATORS Series

240x190x125 mm

380x300x170 mm



	Poles	Switch size	Fuse type	□	240x190x125 mm		380x300x170 mm	
					EMERGENCY SWITCHING	GENERAL USE	EMERGENCY SWITCHING	GENERAL USE
16A	2P	F1	gG 10,3x38mm	1	590.EMF1602	590.GEF1602		
	3P				590.EMF1603	590.GEF1603		
	3P+N				590.EMF1604	590.GEF1604		
	4P				590.EMF1605	590.GEF1605		
32A	2P	F1	gG 10,3x38mm	1	590.EMF3202	590.GEF3202		
	3P				590.EMF3203	590.GEF3203		
	3P+N				590.EMF3204	590.GEF3204		
	4P				590.EMF3205	590.GEF3205		
63A	3P	KF1	DIN-NH	1			590.EMD6303	590.GED6303
	3P		BS		590.EMB6303	590.GEB6303		
	3P+N		DIN-NH		590.EMD6305	590.GED6305		
	3P+N		BS		590.EMB6305	590.GEB6305		
80A	3P	KF1	DIN-NH	1			590.EMD8003	590.GED8003
	3P		BS(*)		590.EMB8003	590.GEB8003		
	3P+N		DIN-NH		590.EMD8005	590.GED8005		
	3P+N		BS(*)		590.EMB8005	590.GEB8005		

□ Pack Quantity

- 3P+N with early make late break neutral pole.
- Equipped with door locking.

- Switch disconnectors units suitable as spare parts available in the General catalogue.
- (*) OSD fuses (not BS standard).
- Fuses not provided.

■ SURFACE MOUNTING - IP55
100A ÷ 160A - 3P, 3P+N

ISOLATORS Series

450x370x180 mm



	Poles	Switch size	Fuse type	□		
					EMERGENCY SWITCHING	GENERAL USE
100A	3P	KF2	DIN-NH	1	590.EMD10003	590.GED10003
	3P		BS		590.EMB10003	590.GEB10003
	3P+N		DIN-NH		590.EMD10005	590.GED10005
	3P+N		BS		590.EMB10005	590.GEB10005
125A	3P	KF2	DIN-NH	1	590.EMD12503	590.GED12503
	3P		BS(*)		590.EMB12503	590.GEB12503
	3P+N		DIN-NH		590.EMD12505	590.GED12505
	3P+N		BS(*)		590.EMB12505	590.GEB12505
160A	3P	KF2	DIN-NH	1	590.EMD16003	590.GED16003
	3P		BS(*)		590.EMB16003	590.GEB16003
	3P+N		DIN-NH		590.EMD16005	590.GED16005
	3P+N		BS(*)		590.EMB16005	590.GEB16005

□ Pack Quantity

- 3P+N with early make late break neutral pole.
- Equipped with door locking.

- Switch disconnectors units suitable as spare parts available in the General catalogue.
- (*) DEO fuses (not BS standard).
- Fuses not provided.

	Padlockable handle in one position (OFF).
	Padlockable handle in two positions (ON/OFF).

ISOLATORS Series

Switch disconnectors with fuses - Aluminium enclosure

■ SURFACE MOUNTING - IP65
16A ÷ 80A - 2P, 3P, 3P+N, 4P

ISOLATORS Series

253x217x93 mm

410x315x128 mm



Poles	Switch size	Fuse type	□	253x217x93 mm		410x315x128 mm	
				EMERGENCY SWITCHING	GENERAL USE	EMERGENCY SWITCHING	GENERAL USE
16A	2P	F1	gG 10,3x38mm	1	590.HEMF1602	590.HGEF1602	
	3P				590.HEMF1603	590.HGEF1603	
	3P+N				590.HEMF1604	590.HGEF1604	
	4P				590.HEMF1605	590.HGEF1605	
32A	2P	F1	gG 10,3x38mm	1	590.HEMF3202	590.HGEF3202	
	3P				590.HEMF3203	590.HGEF3203	
	3P+N				590.HEMF3204	590.HGEF3204	
	4P				590.HEMF3205	590.HGEF3205	
63A	3P	KF1	DIN-NH	1		590.HEMD6303	590.HGED6303
	3P		BS		590.HEMB6303	590.HGEB6303	
	3P+N		DIN-NH		590.HEMD6305	590.HGED6305	
	3P+N		BS		590.HEMB6305	590.HGEB6305	
80A	3P	KF1	DIN-NH	1		590.HEMD8003	590.HGED8003
	3P		BS(*)		590.HEMB8003	590.HGEB8003	
	3P+N		DIN-NH		590.HEMD8005	590.HGED8005	
	3P+N		BS(*)		590.HEMB8005	590.HGEB8005	

□ Pack Quantity

- 3P+N with early make late break neutral pole.
- Equipped with door locking.

- Switch disconnectors units suitable as spare parts available in the General catalogue.
- (*) OSD fuses (not BS standard).
- Fuses not provided.

High rating switch disconnectors with fuses - Hinged sheet steel enclosure



■ SURFACE MOUNTING - IP65 100A ÷ 250A - 3P, 3P+N - TOP/BOTTOM CONNECTION

ISOLATORS Series

300x500x200 mm

400x600x250 mm



Poles	Switch size	Fuse type	□	300x500x200 mm		400x600x250 mm	
				EMERGENCY SWITCHING	GENERAL USE	EMERGENCY SWITCHING	GENERAL USE
100A	3P	DIN-NH	1	590.KEMD10003	590.KGED10003		
	3P	BS		590.KEMB10003	590.KGEB10003		
	3P+N	DIN-NH		590.KEMD10005	590.KGED10005		
	3P+N	BS		590.KEMB10005	590.KGEB10005		
125A	3P	DIN-NH	1	590.KEMD12503	590.KGED12503		
	3P	BS(*)		590.KEMB12503	590.KGEB12503		
	3P+N	DIN-NH		590.KEMD12505	590.KGED12505		
	3P+N	BS(*)		590.KEMB12505	590.KGEB12505		
160A	3P	DIN-NH	1	590.KEMD16003	590.KGED16003		
	3P	BS(*)		590.KEMB16003	590.KGEB16003		
	3P+N	DIN-NH		590.KEMD16005	590.KGED16005		
	3P+N	BS(*)		590.KEMB16005	590.KGEB16005		
200A	3P	DIN-NH	1			590.KEMD20003	590.KGED20003
	3P	BS				590.KEMB20003	590.KGEB20003
	3P+N	DIN-NH				590.KEMD20005	590.KGED20005
	3P+N	BS				590.KEMB20005	590.KGEB20005
250A	3P	DIN-NH	1			590.KEMD25003	590.KGED25003
	3P	BS				590.KEMB25003	590.KGEB25003
	3P+N	DIN-NH				590.KEMD25005	590.KGED25005
	3P+N	BS				590.KEMB25005	590.KGEB25005

□ Pack Quantity

- 3P+N with early make late break neutral pole.
- Equipped with door locking.

- Switch disconnectors units suitable as spare parts available in the General catalogue.
- (*) DEO fuses (not BS standard).
- Fuses not provided.

Padlockable handle in one position (**OFF**).
 Padlockable handle in two positions (**ON/OFF**).

ISOLATORS Series

High rating switch disconnectors with fuses - Hinged sheet steel enclosure

■ SURFACE MOUNTING - IP65 315A ÷ 630A - 3P, 3P+N - TOP/BOTTOM CONNECTION

ISOLATORS Series

500x700x250 mm

600x800x300 mm



Poles	Switch size	Fuse type	□	500x700x250 mm		600x800x300 mm	
				EMERGENCY SWITCHING	GENERAL USE	EMERGENCY SWITCHING	GENERAL USE
315A	3P	DIN-NH	1	590.KEMD31503	590.KGED31503		
	3P	BS		590.KEMB31503	590.KGEB31503		
	3P+N	DIN-NH		590.KEMD31505	590.KGED31505		
	3P+N	BS		590.KEMB31505	590.KGEB31505		
400A	3P	DIN-NH	1	590.KEMD40003	590.KGED40003		
	3P	BS		590.KEMB40003	590.KGEB40003		
	3P+N	DIN-NH		590.KEMD40005	590.KGED40005		
	3P+N	BS		590.KEMB40005	590.KGEB40005		
630A	3P	DIN-NH	1			590.KEMD63003	590.KGED63003
	3P	BS				590.KEMB63003	590.KGEB63003
	3P+N	DIN-NH				590.KEMD63005	590.KGED63005
	3P+N	BS				590.KEMB63005	590.KGEB63005

□ Pack Quantity

- 3P+N with early make late break neutral pole.
- Equipped with door locking.

- Switch disconnectors units suitable as spare parts available in the General catalogue.
- Fuses not provided.

SURFACE MOUNTING - IP65
100A ÷ 250A - 3P, 3P+N - BOTTOM/BOTTOM CONNECTION

ISOLATORS Series

300x500x200 mm

400x600x250 mm



	Poles	Switch size	Fuse type	☒	GENERAL USE	
					GENERAL USE	GENERAL USE
100A	3P	KF2	DIN-NH	1	590.KGED10003B	
	3P		BS		590.KGEB10003B	
	3P+N		DIN-NH		590.KGED10005B	
	3P+N		BS		590.KGEB10005B	
125A	3P	KF2	DIN-NH	1	590.KGED12503B	
	3P		BS(*)		590.KGEB12503B	
	3P+N		DIN-NH		590.KGED12505B	
	3P+N		BS(*)		590.KGEB12505B	
160A	3P	KF2	DIN-NH	1	590.KGED16003B	
	3P		BS(*)		590.KGEB16003B	
	3P+N		DIN-NH		590.KGED16005B	
	3P+N		BS(*)		590.KGEB16005B	
200A	3P	KF3	DIN-NH	1	590.KGED20003B	
	3P		BS		590.KGEB20003B	
	3P+N		DIN-NH		590.KGED20005B	
	3P+N		BS		590.KGEB20005B	
250A	3P	KF3	DIN-NH	1	590.KGED25003B	
	3P		BS		590.KGEB25003B	
	3P+N		DIN-NH		590.KGED25005B	
	3P+N		BS		590.KGEB25005B	

☒ Pack Quantity

- 3P+N with early make late break neutral pole.
- Equipped with door locking.

- Switch disconnectors units suitable as spare parts available in the General catalogue.
- (*) DEO fuses (not BS standard).
- Fuses not provided.

Padlockable handle in one position (OFF).
Padlockable handle in two positions (ON/OFF).

ISOLATORS-FR Series

Fire rated enclosed switch disconnectors

ALUMINIUM/HINGED SHEET STEEL ENCLOSURE - 20A-630A



The Scame Fire Rated ISOLATORS Series maintains continuity of a live circuit whilst exposed to an elevated environmental temperature of 400°C for a period of 120 minutes in compliance with the Standard EN 12101-3 (2015): "Smoke and heat control systems. Specification for powered smoke and heat exhaust ventilators".

This Standard relates to smoke extraction systems and in particular to their motor systems. In order to be able to ensure functional reliability under emergency conditions, all components of the complete ventilation system have to comply with this Standard and the relevant test procedures.

QUALITY MARKS



REFERENCE STANDARDS

BS EN 12101-3

Smoke and heat control systems.
Specification for powered smoke and heat exhaust ventilators

EN 60947-3

Low voltage switchgear and controlgear.
Part 3: switches, disconnectors, switch-disconnectors and fuse-combination unit.

EN 60529

Degrees of protection provided by enclosure.

TECHNICAL CHARACTERISTICS

Polarity:	2P, 3P, 3P+N, 6P
Rated current:	20A-32A-40A-63A-80A-100A-125A-160A-200A-250A-315A-400A-630A
Fire rated classifications according to EN 12101-3 (2015):	F400 (120)
Min-Max. Operating ambient temperature:	-25°C + 60°C
Protection degree:	IP65
IK degree:	IK08 (20A÷160A) IK10 (200A÷630A)
Material:	<ul style="list-style-type: none"> • Continuous-Casting- Aluminium Alloy • Hot dip galvanized steel sheet with zinc
Finishing:	Electrostatic powder coating polyester resin saturated with epoxy resin
Colour:	Red RAL 3020

- 3P+N with early make late break neutral pole.
- Door locking in ON position
- Padlockable handle with 3 padlocks in both OFF and ON position

BEHAVIOUR WITH CHEMICAL AND ATMOSPHERIC AGENTS - ALUMINIUM

Saline solution	Acids		Bases		Solvents				Mineral oil	UV rays
	Concentrated	Diluted	Concentrated	Diluted	Hexane	Benzol	Acetone	Alcohol		
Resistant	Limited Resistance	Resistant	Limited Resistance	Limited Resistance	Resistant	Limited Resistance	Limited Resistance	Resistant	Resistant	Resistant

BEHAVIOUR WITH CHEMICAL AND ATMOSPHERIC AGENTS - SHEET STEEL

Saline solution	Acids		Bases		Solvents				Mineral oil	UV rays
	Concentrated	Diluted	Concentrated	Diluted	Hexane	Benzol	Acetone	Alcohol		
Resistant	Limited Resistance	Resistant	Resistant	Resistant	Resistant	Resistant	Resistant	Resistant	Resistant	Resistant

Resistance values to chemical agents have to be considered indicative.
For further information and specific substances, contact the technical service.

Dimensional drawings: www.scame.com

■ CABLE INLETS

Aluminium/Hinged sheet steel enclosure 2P, 3P, 3P+N, 6P

Rated current (A)	Nr of poles	Enclosure dimensions (mm)	Cable entries
20-32-40	2P, 3P, 3P+N	192x168x80	Blank side
	6P	253x217x93	Blank side
63-80-100	2P, 3P, 3P+N	253x217x93	Blank side
	6P	314x264x122	Blank side
125-160	2P, 3P, 3P+N	410x315x153	Blank side
	6P	500x400x200	Blank side
200-250	3P, 3P+N	700x500x200	Top: Blank side / Bottom: Gland plate
	6P	800x600x300	Top: Blank side / Bottom: Gland plate
315-400	3P, 3P+N	700x500x250	Top: Blank side / Bottom: Gland plate
	6P	800x800x300	Top: Blank side / Bottom: Gland plate
630	3P, 3P+N	800x800x300	Top: Blank side / Bottom: Gland plate
	6P	800x1000x300	Top: Blank side / Bottom: Gland plate

■ TECHNICAL CHARACTERISTICS 2P, 3P, 3P+N, 6P (20A ÷ 100A) / 3P, 3P+N, 6P (125A ÷ 160A)

Switch size				FR1			FR2			FR3	
Rated current In				20	32	40	63	80	100	125	160
Rated insulation voltage	Ui	VAC		690	690	690	800	800	800	800	800
Rated impulse withstand voltage	Uimp	kV		6	6	6	8	8	8	8	8
Thermal current	Ith/Ithe	A		20	32	40	63	80	100	125	160
Rated operational current – Ie	AC21A Resistive loads, including moderate overloads	415V	A	20	32	40	63	80	100	125	160
	AC22A Mixed resistive and inductive loads, including moderate overloads	415V	A	20	32	40	63	80	100	125	160
	AC23A Switching of motor loads or other inductive loads (3 phase/3 poles)	415V	A	20	32	35	63	80	100	125	160
	AC23A Rated operational power (°)	415V	kW	9	15	18.5	35	37	46	55	69
Rated short-time withstand current	Icw (1s)	A		400	400	400	1500	1500	1500	3000	3000
Conditional short circuit current		kAeff		10	10	10	30	30	30	50	50
Associate fuse size for conditional short circuit current - Type gG		A		16	32	40	63	80	100	125	125
Flexible wire		mm ²		1.5-10	1.5-10	1.5-10	10-50	10-50	10-50	10-70	10-70
Rigid wire		mm ²		1.5-16	1.5-16	1.5-16	10-50	10-50	10-50	10-70	10-70

(°) This values are given for guidance and may vary according to the specifics provided by the motor manufacturer.

■ TECHNICAL CHARACTERISTICS - 3P, 3P+N, 6P (200A ÷ 630A)

Switch size				FR4		FR5		FR6
Rated current In				200	250	315	400	630
Rated insulation voltage	Ui	VAC		1000	1000	1000	1000	1000
Rated impulse withstand voltage	Uimp	kV		8	8	8	8	8
Thermal current	Ith/Ithe	A		200	250	315	400	630
Rated operational current – Ie	AC21A Resistive loads, including moderate overloads	415V	A	200	250	315	400	630
	AC22A Mixed resistive and inductive loads, including moderate overloads	415V	A	200	250	315	400	630
	AC23A Switching of motor loads or other inductive loads (3 phase/3 poles)	415V	A	200	250	315	400	630
	AC23A Rated operational power (°)	415V	kW	105	130	165	210	330
Rated short-time withstand current	Icw (1s)	A		13	13	13	13	13
Conditional short circuit current		kAeff		50	50	50	50	50
Associate fuse size for conditional short circuit current - Type gG		A		200	250	315	400	630
Terminal bolt size		mm ²		M8(●)/M10	M10	M10	M10	M12
Palm width		mm		25	25	25	25	30

(°) These values are given as guidance and may vary according to the specifics provided by the motor manufacturer.

(●) For 6P version.





ISOLATORS-FR Series

Fire rated enclosed switch disconnectors - Aluminium enclosure

SURFACE MOUNTING - IP65
20A ÷ 160A - 2P, 3P, 3P+N, 6P



ISOLATORS-FR Series

192x168x80 mm 253x217x93 mm 314x264x122 mm 410x315x153 mm 500x400x200 mm

Poles	Switch size	Pack Quantity	EMERGENCY SWITCHING				
							
20A	2P	1	590.FEM2002				
	3P	1	590.FEM2003				
	3P+N	1	590.FEM2005				
	6P	1	590.FEM2006				
32A	2P	1	590.FEM3202				
	3P	1	590.FEM3203				
	3P+N	1	590.FEM3205				
	6P	1	590.FEM3206				
40A	2P	1	590.FEM4002				
	3P	1	590.FEM4003				
	3P+N	1	590.FEM4005				
	6P	1	590.FEM4006				
63A	2P	1	590.FEM6302				
	3P	1	590.FEM6303				
	3P+N	1	590.FEM6305				
	6P	1	590.FEM6306				
80A	2P	1	590.FEM8002				
	3P	1	590.FEM8003				
	3P+N	1	590.FEM8005				
	6P	1	590.FEM8006				
100A	2P	1	590.FEM10002				
	3P	1	590.FEM10003				
	3P+N	1	590.FEM10005				
	6P	1	590.FEM10006				
125A	3P	1	590.FEM12503				
	3P+N	1	590.FEM12505				
	6P	1	590.FEM12506 (*)				
160A	3P	1	590.FEM16003				
	3P+N	1	590.FEM16005				
	6P	1	590.FEM16006 (*)				

 Pack Quantity

- The full range of ISOLATORS-FR from 20 to 630A is also available with auxiliary contact.
To order it just add ".U" at the end of the part number.
- The full range of ISOLATORS-FR from 20 to 630A is also available with the handle in black color.
To order it just replace "FEM" with "FGE" in the part number.
- (*) ISOLATORS-FR 125A and 160A in 6P configurations are provided with sheet steel enclosure with lid (IK10).

	Padlockable handle in one position (OFF).
	Padlockable handle in two positions (ON/OFF).

Fire rated enclosed switch disconnectors - Hinged sheet steel enclosure



■ SURFACE MOUNTING - IP65
200A ÷ 630A - 3P, 3P+N, 6P

ISOLATORS-FR Series

700x500x200 mm 700x500x250 mm 800x600x300 mm 800x800x300 mm 800x1000x300 mm

Poles	Switch size	□	EMERGENCY SWITCHING				
			□	□	□	□	□
200A	3	1	590.FEM20003				
	3P+N	FR4	590.FEM20005				
	6P	1	590.FEM20006				
250A	3	1	590.FEM25003				
	3P+N	FR4	590.FEM25005				
	6P	1	590.FEM25006				
315A	3	1	590.FEM31503				
	3P+N	FR5	590.FEM31505				
	6P	1	590.FEM31506				
400A	3	1	590.FEM40003				
	3P+N	FR5	590.FEM40005				
	6P	1	590.FEM40006				
630A	3	1	590.FEM63003				
	3P+N	FR6	590.FEM63005				
	6P	1	590.FEM63006				

□ Pack Quantity

- The full range of ISOLATORS-FR from 20 to 630A is also available with with auxiliary contact.
To order it just add ".U" at the end of the part number.

- The full range of ISOLATORS-FR from 20 to 630A is also available with the handle in black color.
To order it just replace "FEM" with "FGE" in the part number.
- High ratings versions from 200A up to 630A are provided with hinged door and double top and bottom gland plate, durable metal hinges and door locks.

ISOLATORS-FR SERIES

INNER SWITCH DISCONNECTORS

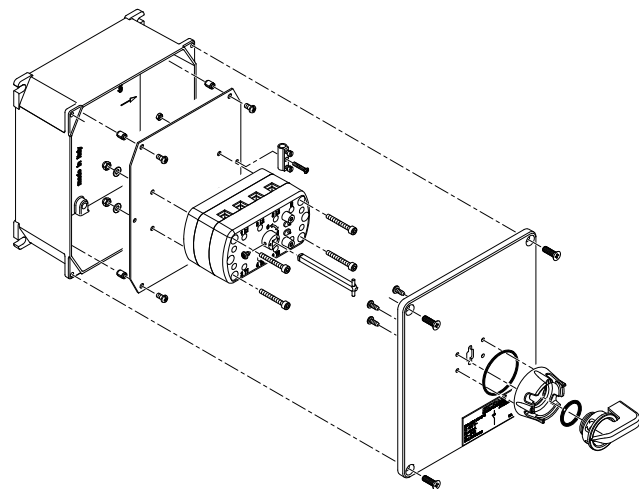

Inner switch disconnectors have been specifically developed to be resistant at very high temperature for long time. The thermosetting material - Glass Reinforced Polyester (GRP) - used for their housing is the best polymer to ensure resistance to high temperature (GW 960°) and guarantee dimensional stability.

Inner switch disconnectors are mounted on the rear plate (box mounting) for easier wiring and maintenance operations. Versions equipped with auxiliary contacts are also available. Enclosures are equipped with metal door locking in on position and handles are padlockable in both on and off position.

ISOLATORS Series

Change-over switch disconnectors I/O/II

■ THERMOPLASTIC/ALUMINIUM/STAINLESS STEEL/SHEET STEEL ENCLOSURE - 16A-160A



The ISOLATORS range of enclosed change-over switches offers the possibility to manage normal and emergency lines, or different types of applications such as motor rotation inversion and much more still.

The range available with ratings from 16 to 160A and enclosures are available in thermoplastic, aluminium and stainless steel, designed to cover all applications in the service and industrial sectors.

■ REFERENCE STANDARDS

EN 60947-3

Low voltage switchgear and controlgear.
Part 3: switches, disconnectors, switch-disconnectors and fuse-combination unit.

EN 60529

Degrees of protection provided by enclosure.

■ TECHNICAL CHARACTERISTICS

Polarity:	3P, 3P+N
Rated current:	16A-25A-32A-40A-63A 80A-100A-125A-160A
Protection degree:	IP65 (aluminium - stainless steel) IP66/IP69 (20A÷40A thermoplastic) IP55 (63÷160A thermoplastic)
Operating ambient temperature according to the reference standard:	-5°C +40°C
Min-Max. operating ambient temperature:	-25°C +60°C
Material:	Thermoplastic Die-cast aluminium Stainless steel 304L (316L stainless steel on request)
IK degree:	IK09 Thermoplastic IK10 Aluminium/Stainless Steel 20A-140A IK08 Aluminium 63A-160A
Glow wire test:	650°C (Thermoplastic)
Colour:	Grey RAL7035 (Thermoplastic) Grey RAL7015 (Aluminium)

3P+N with early make late break neutral pole.

ISOLATORS Series (Thermoplastic)

■ BEHAVIOUR WITH CHEMICAL AND ATMOSPHERIC AGENTS

Saline solution	Acids		Bases		Solvents				Mineral oil	UV rays
	Concentrated	Diluted	Concentrated	Diluted	Hexane	Benzol	Acetone	Alcohol		
Resistant	Limited Resistance	Resistant	Resistant	Resistant	Not Resistant	Not Resistant	Not Resistant	Limited Resistance	Limited Resistance	Resistant

Resistance values to chemical agents have to be considered indicative.

Dimensional drawings: www.scame.com

For further information and specific substances, contact the technical service.

■ CABLE INLETS

Thermoplastic insulated enclosure 3P, 3P+N

Rated current (A)	Nr of poles	Enclosure dimensions (mm)	Cable entries		
			Top/Bottom	2xM32	Knock-outs/Blank side
16-25-32-40	3P, 3P+N	160x220x114	Top/Bottom	2xM32	Knock-outs/Blank side
			Rear	-	Blank side (*)
63-80-100	3P, 3P+N	228x308x128	Top	-	Blank side (*)
			Bottom	-	Blank side (*)
			Rear	-	Blank side (*)
			Rear	-	Blank side (*)
125-160	3P, 3P+N	308x338x128	Top	-	Blank side (*)
			Bottom	-	Blank side (*)
			Rear	-	Blank side (*)

(*) Perforated or threaded entries on request.

ISOLATORS Series (Aluminium)

■ BEHAVIOUR WITH CHEMICAL AND ATMOSPHERIC AGENTS

Saline solution	Acids		Bases		Solvents				Mineral oil	UV rays
	Concentrated	Diluted	Concentrated	Diluted	Hexane	Benzol	Acetone	Alcohol		
Resistant	Limited Resistance	Resistant	Limited Resistance	Limited Resistance	Resistant	Limited Resistance	Limited Resistance	Resistant	Resistant	Resistant

Resistance values to chemical agents have to be considered indicative.

Dimensional drawings: www.scame.com

For further information and specific substances, contact the technical service.

■ CABLE INLETS

Aluminium enclosure 3P, 3P+N

Rated current (A)	Nr of poles	Enclosure dimensions (mm)	Cable entries		
			Top (*)	2xM32	Threaded entries
16-25-32-40	3P, 3P+N	150x210x107	Bottom	2xM32	Threaded entries
			Rear	-	Blank side (*)
			Rear	-	Blank side (*)
63-80-100	3P, 3P+N	264x315x122	Top	-	Blank side (*)
			Bottom	-	Blank side (*)
			Rear	-	Blank side (*)
125-160	3P, 3P+N	315x410x128	Top	-	Blank side (*)
			Bottom	-	Blank side (*)
			Rear	-	Blank side (*)

(*) Perforated or threaded entries on request.

(*) "A" version blank side bottom cable entries only.

ISOLATORS Series

Change-over switch disconnectors I/O/II

ISOLATORS Series (Stainless steel - Sheet steel)

■ BEHAVIOUR WITH CHEMICAL AND ATMOSPHERIC AGENTS

Saline solution	Acids		Bases		Solvents				Mineral oil	UV rays
	Concentrated	Diluted	Concentrated	Diluted	Hexane	Benzol	Acetone	Alcohol		
Resistant	Limited Resistance	Resistant	Resistant	Resistant	Resistant	Resistant	Resistant	Resistant	Resistant	Resistant

Resistance values to chemical agents have to be considered indicative.

Dimensional drawings: www.scame.com

For further information and specific substances, contact the technical service.

■ CABLE INLETS

Stainless steel enclosure 3P, 3P+N

Rated current (A)	Nr of poles	Enclosure dimensions (mm)	Cable entries		
16-25-32-40 63-80-100	3P, 3P+N	226x306x115	Top	-	Blank side
			Bottom	-	Blank side
			Rear	-	Blank side
125-160	3P, 3P+N	312x412x115	Top	-	Blank side
			Bottom	-	Blank side
			Rear	-	Blank side

Perforated or threaded entries on request.

■ CABLE INLETS

Hinged sheet steel enclosure 3P, 3P+N Top/Bottom entries

Rated current (A)	Nr of poles	Dimension (mm)	Cable entries	
100-125	3P, 3P+N	400x500x200	Top	Blank side
			Bottom	Gland plate
160	3P, 3P+N	500x700x250	Top	Blank side
			Bottom	Gland plate
200-250	3P, 3P+N	600x800x300	Top	Blank side
			Bottom	Gland plate
315-400-500	3P, 3P+N	800x800x300	Top	Blank side
			Bottom	Gland plate
630	3P, 3P+N	100x100x300	Top	Blank side
			Bottom	Gland plate

■ TECHNICAL CHARACTERISTICS 3P, 3P+N

Switch size			C1				C2			C3		
Rated current I _n			16A	25A	32A	40A	63A	80A	100A	125A	160A	
Rated insulation voltage	U _i	VAC	800	800	800	800	800	800	800	800	800	
Rated impulse withstand voltage	U _{imp}	kV	8	8	8	8	8	8	8	8	8	
Thermal current	I _{th} /I _{the}	A	16	25	32	40	63	80	100	125	160	
Rated operational current – I _e	AC21A Resistive loads, including moderate overloads	415V	A	16	25	32	40	63	80	100	125	160
		500V	A	16	25	32	40	63	80	100	125	160
		690V	A	16	25	32	40	63	80	100	125	160
	AC22A Mixed resistive and inductive loads, including moderate overloads	415V	A	16	25	32	40	63	80	100	125	160
		500V	A	16	25	32	40	63	80	100	125	160
		690V	A	16	25	32	63	63	63	100	125	160
	AC23A Switching of motor loads or other highly inductive loads (3 phase / 3 pole)	415V	A	16	25	32	40	63	80	100	125	160
		500V	A	16	25	32	40	63	63	63	125	125
		690V	A	16	25	25	25	32	32	32	100	100
	AC23A Rated operational power (°)	415V	kW	7,5	11	15	18,5	35	37	46	55	69
	Rated short time withstand current	I _{cw} (1s)	A	1100	1100	1100	1100	1500	1500	1500	3000	3000
	Conditional short circuit current	kA _{eff}		50	50	50	50	50	50	30	50	50
Associate fuse size for conditional short circuit current - Type gG		A	16	25	32	40	63	80	100	125	125	
Flexible wire		mm ²	4-25	4-25	4-25	4-25	10-50	10-50	10-50	10-70	10-70	
Rigid wire		mm ²	4-25	4-25	4-25	4-25	10-50	10-50	10-50	10-70	10-70	

(°) This values are given for guidance and may vary according to the specifics provided by the motor manufacturer.

■ SURFACE MOUNTING - IP65
16A ÷ 160A - 3P, 3P+N

ISOLATORS Series



	Poles	Switch size	☐	Thermoplastic	Aluminium	Stainless Steel	Sheet Steel
16A	3P	C1	1/5	590.GE1603-C	590.HGE1603-C	590.SGE1603-C	
	3P+N			590.GE1605-C	590.HGE1605-C	590.SGE1605-C	
25A	3P	C1	1/5	590.GE2503-C	590.HGE2503-C	590.SGE2503-C	
	3P+N			590.GE2505-C	590.HGE2505-C	590.SGE2505-C	
32A	3P	C1	1/5	590.GE3203-C	590.HGE3203-C	590.SGE3203-C	
	3P+N			590.GE3205-C	590.HGE3205-C	590.SGE3205-C	
40A	3P	C1	1/5	590.GE4003-C	590.HGE4003-C	590.SGE4003-C	
	3P+N			590.GE4005-C	590.HGE4005-C	590.SGE4005-C	
63A (*)	3P	C2	1/5	590.GE6303-C	590.HGE6303-C	590.SGE6303-C	
	3P+N			590.GE6305-C	590.HGE6305-C	590.SGE6305-C	
80A (*)	3P	C2	1/5	590.GE8003-C	590.HGE8003-C	590.SGE8003-C	
	3P+N			590.GE8005-C	590.HGE8005-C	590.SGE8005-C	
100A (*)	3P	C2	1/5	590.GE10003-C	590.HGE10003-C	590.SGE10003-C	
	3P+N			590.GE10005-C	590.HGE10005-C	590.SGE10005-C	
	3P	KA1	1/5				590.KGE10003-C
	3P+N						590.KGE10005-C
125A (*)	3P	C3	1	590.GE12503-C	590.HGE12503-C	590.SGE12503-C	
	3P+N			590.GE12505-C	590.HGE12505-C	590.SGE12505-C	
	3P	KA1	1				590.KGE12503-C
	3P+N						590.KGE12505-C
160A (*)	3P	C3	1	590.GE16003-C	590.HGE16003-C	590.SGE16003-C	
	3P+N			590.GE16005-C	590.HGE16005-C	590.SGE16005-C	
	3P	KA2	1				590.KGE16003-C
	3P+N						590.KGE16005-C
200A	3P	KA2	1				590.KGE20003-C
	3P+N						590.KGE20005-C
250A	3P	KA2	1				590.KGE25003-C
	3P+N						590.KGE25005-C
315A	3P	KA3	1				590.KGE31503-C
	3P+N						590.KGE31505-C
400A	3P	KA3	1				590.KGE40003-C
	3P+N						590.KGE40005-C
500A	3P	KA3	1				590.KGE50003-C
	3P+N						590.KGE50005-C
630A	3P	KA4	1				590.KGE63003-C
	3P+N						590.KGE63005-C

☐ Pack Quantity

- (*) IP55 for thermoplastic versions.

- Dimensions: see page 59, 60.

- Switch disconnectors units suitable as spare parts available in the General catalogue.

ISOLATORS Series Accessories

■ SIMULTANEOUS AUXILIARY CONTACT - DISCONNECTORS SIZE Y1-YF1-D1-Y2

COMMAND Series



Description	☐	Y1-YF1-D1	Y2
1 NC contact	1/10	590.PL004001	
1 NO contact	1/10	590.PL004002	
1 NC contact	1/10		590.PL004003
1 NO contact	1/10		590.PL004004

☐ Pack Quantity
- Max 2 auxiliary contacts.

■ EARLY BREAK AUXILIARY CONTACT - DISCONNECTORS SIZE Y1-YF1-D1-Y2

COMMAND Series



Description	☐	Y1-YF1-D1	Y2
1 NC/NO contact	1/10	590.PL004005	
1 NC/NO contact	1/10		590.PL004006

☐ Pack Quantity
- Max 2 auxiliary contacts.

■ EARLY BREAK AUXILIARY CONTACT - DISCONNECTORS SIZE Y3-Y4-Y5-D3-D5

COMMAND Series



Description	☐	
1 NO/NC contact	1/10	590.PL005

☐ Pack Quantity
- Max 2 auxiliary contacts.

■ EARLY BREAK AUXILIARY CONTACT - ISOLATORS-FR DISCONNECTORS SIZE FR1-FR2-FR3

COMMAND Series



Description	☐	
1 NO/NC contact	1/10	590.PL004008

☐ Pack Quantity
- Max 2 auxiliary contacts.

■ EARLY BREAK AUXILIARY CONTACT - DISCONNECTORS SIZE K1-K2-K3-K4-K5-K6-KF1-KF2-KF3-KF4-KF5

COMMAND Series



Description	Pack Quantity	Switch size		
		K1-K2-KF1-KF2	K3-K5-K6-KF3-KF5	K4-KF4
1 NO/NC contact	1/10	590.PL006011	590.PL006012	590.PL006013
2 NO/NC contact	1/10	590.PL006021	590.PL006022	590.PL006023

Pack Quantity
 - Max 2 auxiliary contacts (2NO/2NC).

■ TERMINAL PROTECTION COVER

COMMAND Series



Switch size	Pack Quantity	Terminal Protection Cover	
		TOP TERMINALS	BOTTOM TERMINALS
K1-KF1	1/10	590.KMT11	590.KMT12
K2-KF2	1/10	590.KMT21	590.KMT22
K3-KF3	1/10	590.KMT31	590.KMT32
K4-KF4	1/10	590.KMT41	590.KMT42
K5-KF5	1/10	590.KMT51	590.KMT52

Pack Quantity

■ DOOR-LOCKING KIT - DISCONNECTORS SIZE Y1-Y2

ISOLATORS Series



Description	Switch size	Pack Quantity	Part Number
Door-locking kit thermoplastic enclosures	Y1	1/12	590.BK040
Door-locking kit aluminium enclosures			590.BK040H
Door-locking kit thermoplastic enclosures	Y2	1/5	590.BK080
Door-locking kit aluminium enclosures			590.BK080H

Pack Quantity.
 - Only for ISOLATORS-AL and ISOLATORS-TP Series (previous version).

ZP00871-GB-4
8 001636 4 15949



ScameOnLine

www.scame.com
export@scame.com

SCAME PARRE S.p.A.
VIA COSTA ERTA, 15
24020 PARRE (BG) ITALY
TEL. +39 035 705000
FAX +39 035 703122

